

RES-430

®

Operating Instructions

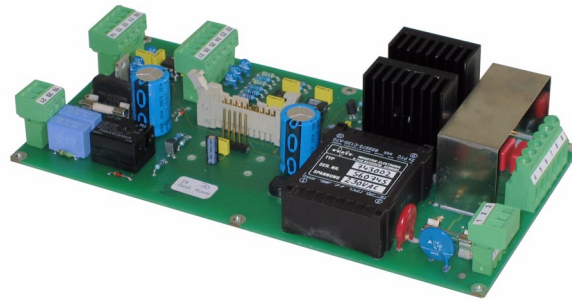

Important features

- Microprocessor technology
- LC display (green), 4 lines, 20 characters (multilingual)
- Automatic zero calibration (AUTOCAL)
- Automatic optimization (AUTOTUNE)
- Automatic frequency adjustment
- Secondary control
- Heatsealing band alloy and temperature range selectable
- Time control, heatsealing time and cooling time settable
- Configurable relay output, e.g. "end of cycle"
- Time or temperature-controlled cooling phase
- 0...10VDC analog output for ACTUAL temperature
- Load cell interface for monitoring closing pressure
- Serial data interface (optional)
- Fault diagnosis

Contents

1	Safety and warning notes	3	10	Controller functions	27
1.1	Use	3	10.1	Indicators and controls	27
1.2	Heatsealing band	3	10.2	Display	27
1.3	Impulse transformer	3	10.3	Navigation in the menus	29
1.4	Line filter	3	10.4	Menu structure	31
1.5	Warranty provisions	3	10.5	Two-digit numbering system up to SW revision 006	33
1.6	Standards / CE marking	4	10.6	Temperature setting (set point selection)	34
2	Application	4	10.7	Temperature indication / actual value output	34
3	Principle of operation	5	10.8	Automatic zero calibration (AUTOCAL)	35
4	Description of the controller	5	10.9	"FOOT SWITCH" signal	36
5	Modifications (MODs) / optical data interface	6	10.10	Hold time for "FOOT SWITCH" signal	36
5.1	Modifications	6	10.11	"START" signal (HEAT)	36
5.2	Optional data interface (piggyback module)	6	10.12	Cycle counter	37
6	Technical data	8	10.13	Single/double sealing	37
7	Dimensions / front panel cutout	10	10.14	Hold mode	37
7.1	Motherboard	10	10.15	Locking the "HAND" key	38
7.2	Display terminal	11	10.16	Locking the Configuration menu	38
8	Installation	12	10.17	Undervoltage detection	39
8.1	Installation procedure	12	10.18	System monitoring / alarm output	42
8.2	Installation steps	12	10.19	Error messages	42
8.3	Power supply	13	10.20	Fault areas and causes	45
8.4	Wiring diagram with relay K1 (standard)	14	11	Factory settings	46
8.5	Wiring diagram with solenoid drive (optional)	15	11.1	Ropex settings	46
9	Startup and operation	16	11.2	Customer settings	47
9.1	View of the controller	16	12	Maintenance	47
9.2	General controller configuration	17	13	How to order	48
9.3	Time control (timer function)	18	14	Index	49
9.4	Temperature diagnosis	22			
9.5	Load cell interface / temperature sensor	23			
9.6	Heatsealing band	24			
9.7	Startup procedure	25			

1 Safety and warning notes

This RESISTRON temperature controller is manufactured according to DIN EN 61010-1. In the course of its manufacture it passed through quality assurance, whereby it was subjected to extensive inspections and tests.

It left the factory in perfect condition.

The recommendations and warning notes contained in these operating instructions must be complied with, in order to guarantee safe operation.

The device can be operated within the limits indicated in the "Technical Data" without impairing its operational safety. Installation and maintenance may only be performed by technically trained, skilled persons who are familiar with the associated risks and warranty provisions.

1.1 Use

RESISTRON temperature controllers may only be used for heating and temperature control of heatsealing bands which are expressly suitable for them, and providing the regulations, notes and warnings contained in these instructions are complied with.

 **In case of non-compliance or use contrary to the intended purpose, there is a risk that safety will be impaired or that the heatsealing band, electrical wiring, transformer etc. will overheat. Ensuring such compliance is the personal responsibility of the user.**

1.2 Heatsealing band

A basic prerequisite for reliable and safe operation of the system is the use of suitable heatsealing bands.

 **The resistance of the heatsealing band which is used must have a positive minimum temperature coefficient in order to guarantee trouble-free operation of the RESISTRON temperature controller.**

The temperature coefficient must be specified as follows:

$$TCR \geq 10 \times 10^{-4} K^{-1}$$

e.g. Alloy-20: TCR = 1100 ppm/K
NOREX: TCR = 3500 ppm/K

The RESISTRON temperature controller must be set and coded according to the temperature coefficient of the heatsealing band.

 **The use of incorrect alloys with too low a temperature coefficient and incorrect coding of the RESISTRON temperature controller leads to uncontrolled heating and ultimately to burn-out of the heatsealing band!**

The heatsealing bands that were originally supplied must be identified by their detailed specification, part number or some other means to ensure that all replacement bands are identical.

1.3 Impulse transformer

A suitable impulse transformer is necessary to ensure that the control loop functions perfectly. This transformer must be designed according to VDE 0570/EN 61558 (isolating transformer with reinforced insulation) and have a one-section bobbin. When the impulse transformer is installed, suitable shock protection must be provided in accordance with the national installation regulations for electrical equipment. In addition, water, cleaning solutions and conductive fluids must be prevented from seeping into the transformer.

 **Incorrect installation of the impulse transformer impairs electrical safety.**

1.4 Line filter

The use of an original ROPEX line filter is mandatory in order to comply with the standards and provisions mentioned in section 1.6 "Standards / CE marking" on page 4. This device must be installed and connected according to the instructions contained in section 8.3, "Power supply" as well as the separate documentation enclosed with the line filter.

1.5 Warranty provisions

The statutory provisions for warranties apply for a period of 12 months following the delivery date. All devices are tested and calibrated in the factory. Devices that have been damaged due to faulty

connections, dropping, electrical overloading, natural wear, incorrect or negligent handling, chemical influences or mechanical overloading as well as devices that have been modified, relabeled or otherwise altered by the customer, for example in an attempt to repair them or install additional components, are excluded from the warranty.

Warranty claims must be examined in the factory and approved by ROPEX.

1.6 Standards / CE marking

The controller described here complies with the following standards, provisions and directives:

- DIN EN 61010-1 Safety provisions for electrical measuring, control and laboratory devices (low voltage directive).
Overvoltage category III, pollution severity 2, safety class II.
- DIN EN 60204-1 Electrical equipment of machines (machinery directive)
- EN 50081-1 EMC interference emissions according to EN 55011, group 1, class B
- EN 50082-2 EMC interference immunity: ESDs, RF radiation, bursts, surges.

Compliance with these standards and provisions is only guaranteed if original accessories and/or peripheral components approved by ROPEX are used. If not, then the equipment is operated on the user's own responsibility.

The CE marking on the controller confirms that the device itself complies with the above-mentioned standards.

It does not imply, however, that the overall system also fulfils these standards.

It is the responsibility of the machine manufacturer and of the user to verify the completely installed, wired and operationally ready system in the machine with regard to its conformity with the safety provisions and the EMC directive (see also section 8.3, "Power supply"). If peripheral components (e.g. the transformer or the line filter) from other manufacturers are used, no functional guarantee can be provided by ROPEX.

2 Application

This RESISTRON temperature controller is an integral part of the "series 400", the outstanding feature of which is its microprocessor technology. All RESISTRON temperature controllers are used to control the temperature of heating elements (heatsealing bands, beaded bands, cutting wires, heatsealing blades, solder elements etc.), as required in a variety of heatsealing processes.

The controller is most commonly used for impulse-heatsealing PE and PP films in simple table welding machines and welding presses:

- Pouch, filling and sealing machines
- Film wrapping machines

- Pouch-making machines
- L-sealers
- etc.

The use of RESISTRON temperature controllers results in:

- Repeatable quality of the heatseals under any conditions
- Increased machine capacity
- Extended life of the heatsealing bands and teflon coatings
- Simple operation and control of the sealing process

3 Principle of operation

The resistance of the heatsealing band, which is temperature-sensitive, is monitored 50x per second (60x at 60Hz) by measuring the current and voltage. The temperature calculated with the help of these measurements is displayed and compared with the set point.

The secondary voltage of the impulse transformer is adjusted by phase-angle control if the measured values deviate from the set point. The resulting change in the current through the heatsealing band leads to a change in the band temperature and thus also its resistance. This change is measured and evaluated by the RESISTRON temperature controller.

The control loop is closed: ACTUAL temperature = SET temperature. Even minute thermal loads on the heatsealing band are detected and can be corrected quickly and precisely.

The thermoelectric control loop which is formed has a highly dynamic response because purely electrical variables are measured at a high sampling rate.

PLEASE NOTE!

RESISTRON temperature controllers play a significant role in enhancing the performance of modern machines. However, the full benefit can only be obtained from the advanced technology offered by this control system if all the system components, in other words the heatsealing band, the impulse transformer, the wiring, the timing signals and the controller itself, are compatible with one another.

We will be pleased to contribute our many years of experience towards optimizing your heatsealing system.

4 Description of the controller

The microprocessor technology endows the RES-430 RESISTRON temperature controller with previously unattainable capabilities:

- Very simple operation thanks to AUTOCAL, the automatic zero calibration function.
- Good dynamic response of the control system thanks to AUTOTUNE, which adapts automatically to the controlled system.
- High precision thanks to further improved control accuracy and linearization of the heatsealing band characteristic.
- High flexibility: Secondary voltage range from 12V to 42V, current range from 20A to 90A.
- Automatic adjustment to the line frequency in the range from 47Hz to 63Hz.
- Increased protection against dangerous conditions, such as overheating of the heatsealing band.

A time control (timer) function integrated in the controller enables the complete heatsealing process to be controlled on simple machines, such as table heatsealing tools. A configurable relay output can be used to drive motors, energize magnets etc.

The process data is represented on an LC display with 4 lines and 20 characters. Various display languages can be selected.

The real heatsealing band temperature is visualized on the display both as a digital number in °C and in the form of a dynamic bar.

In addition to the digital and bar indications on the display, the ACTUAL temperature of the heatsealing band is supplied to an analog 0...10VDC output. The real heatsealing band temperature can thus be visualized on an external temperature meter (e.g. ATR-x).

The RESISTRON temperature controller RES-430 also features an integrated fault diagnosis function, which tests both the external system (heatsealing band, wiring etc.) and the internal electronics and outputs a selective error message in case of a fault.

The menu in the temperature controller itself can be used to adapt to different heatsealing band alloys (Alloy-20, NOREX etc.) and set the required temperature range (0...300°C, 0...500°C etc.).

The RESISTRON temperature controller RES-430 consists of two components: a motherboard with a power section for installation in the machine frame and a separate display terminal. The compact design and

the plug-in connections make this controller easy to install.

5 Modifications (MODs) / optical data interface

5.1 Modifications

No modifications are available for the RESISTRON temperature controller RES-430.

5.2 Optional data interface (piggyback module)

A serial data interface (piggyback module) is optionally available for the RES-430 controller.

This module can be ordered separately and retrofitted onto the motherboard. It is connected to a PC by means of a serial data cable (↪ section 13 „How to order“ on page 48).

5.2.1 Scope of supply / installation

The serial piggyback module is supplied with spacers for installation on the motherboard of the RES-430. Proceed as follows to install the module.

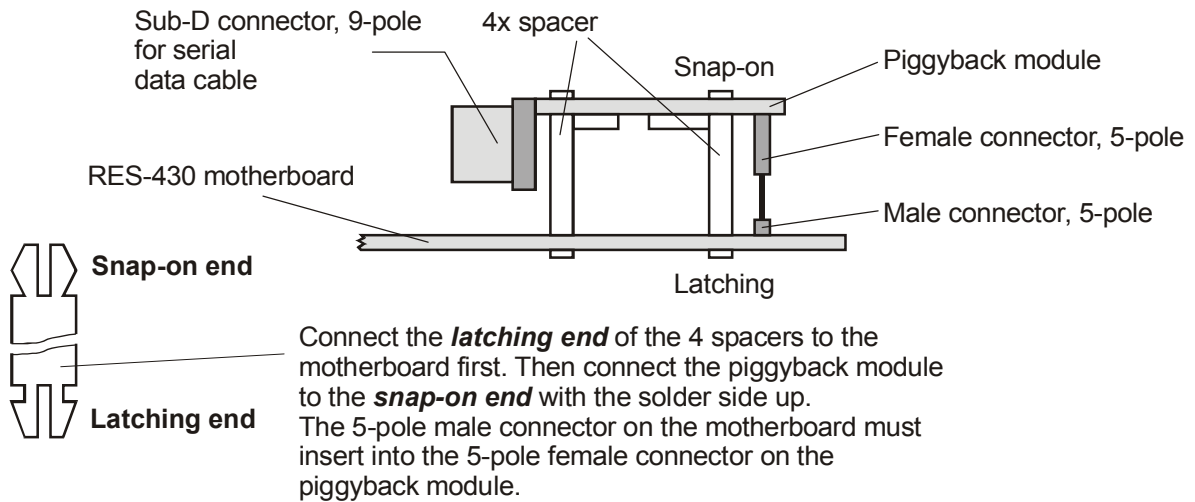

Schematic diagram:

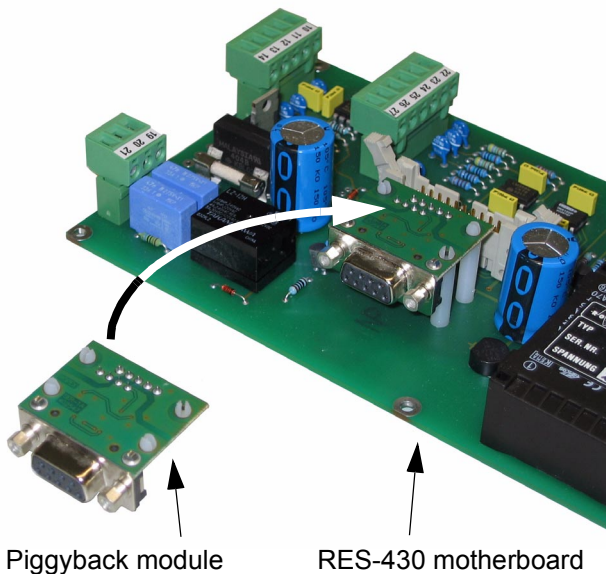



5.2.2 Visualization software

A visualization software tool is provided for data communication with a PC. This software shows all the data for a heatsealing cycle (ACTUAL temperature, closing force). You can also export the data as a CSV file for further processing in another PC program.

In addition, the software permits the values in the Configuration and Settings menus to be transferred to the controller or read from it. This visualization software is described in a separate document.

6 Technical data

Type of construction	<p><u>RES-430 motherboard with power section:</u> Open design for installation in the machine frame Dimensions (L x W): 210 x 110mm, height: 45mm (incl. terminals)</p> <p><u>T-430 display terminal:</u> For installation in the machine frame Dimensions (W x H): 144 x 72mm; depth: 66mm (incl. connecting cables)</p>
Line voltage	115VAC, 230VAC, tolerance: +10% / -15% depending on device version (↪ section 13 „How to order“ on page 48)
Line frequency	47...63Hz, automatic adjustment to frequencies in this range
Heatsealing band type and temperature range	Several different ranges can be selected on the controller in the Configuration menu: Default: Temperature coefficient 1100ppm (Alloy 20), 0...300°C
Heatsealing band voltage (secondary voltage of impulse transformer)	12...42VAC
Max. load current (max. secondary current of impulse transformer) Terminals 5, 6, 7, 8	Two heatsealing bands: $I_{\text{sec max}} = 90\text{A}$ (per heatsealing band: $I_{\text{max}} = 45\text{A}$) One heatsealing band: $I_{\text{sec max}} = 70\text{A}$  If only one heatsealing band is used, terminals 7+8 must be externally jumpered with a high current cable in order to avoid malfunctions or damage to the controller.
Min. load current	Up to SW revision 007: $I_{\text{sec min}} = 30\text{A}$ SW revision 008 or higher: $I_{\text{sec min}} = 20\text{A}$
Analog output (actual value) Terminals 10+11	0...10V DC, $I_{\text{max}} = 5\text{mA}$ Equivalent to 0...300°C or 0...500°C
START with contact Terminals 12+14	Switching threshold: 3.5VDC, $U_{\text{max}} = 5\text{VDC}$, $I_{\text{max}} = 5\text{mA}$
FOOT SWITCH with contact Terminals 12+13	Switching threshold: 3.5VDC, $U_{\text{max}} = 5\text{VDC}$, $I_{\text{max}} = 5\text{mA}$
Relay K1 Terminals 19, 20, 21	Changeover contact, potential-free, $U_{\text{max}} = 240\text{VAC}/100\text{VDC}$, $I_{\text{max}} = 1.5\text{A}$ Interference suppression with 47nF / 560ohms for each terminal
Solenoid drive output (optional, instead of K1) Terminals 15, 16, 17, 18	$U_{\text{max}} = 30\text{VAC}$ (supply voltage at terminals 17+18) $I_{\text{max}} = 2\text{A}$
Load cell interface Terminals 22, 23, 24, 25	For load cells with 2mV/V, $R_{\text{min}} = 165\text{ohms}$ Supply voltage (terminals 22+25): $U_{\text{VCC}} = 5\text{VDC}$

Temperature sensor Terminals 26+27	Measuring range: 0...+80°C, For connecting a Philips Type KTY-81-121 temperature sensor
Display	LC display (green), 4 lines, 20 characters
Ambient temperature	+5...+45°C
Degree of protection	<u>Motherboard:</u> IP00 <u>Display terminal:</u> Front: IP42 (IP65 with transparent front cover, Art No. 887000) Back: IP20
Installation	<u>Motherboard:</u> 6 fixing holes (diameter: 3.2mm) for screw mounting <u>Display terminal:</u> Installed in front panel cutout with (W x H) 138 ^(+0.2) x 68 ^(+0.2) mm Fastened with clamps
Weight	Motherboard: Approx. 0.5kg (incl. connector plug-in parts) Display terminal: Approx. 0.4kg
Housing material Display terminal	Black plastic, type Noryl SE1 GFN2
Connecting cables Type / cross-sections	Terminals 4...9: Rigid or flexible; 0.2...4.0mm ² (AWG 24...10) with screw terminals Terminals 1...3, 10...27: Rigid or flexible; 0.2...2.5mm ² (AWG 24...12) with plug-in connections  If ferrules are used, they must be crimped in accordance with DIN 46228 and IEC/EN 60947-1. This is essential for proper electrical contact in the terminals.

7 Dimensions / front panel cutout

7.1 Motherboard

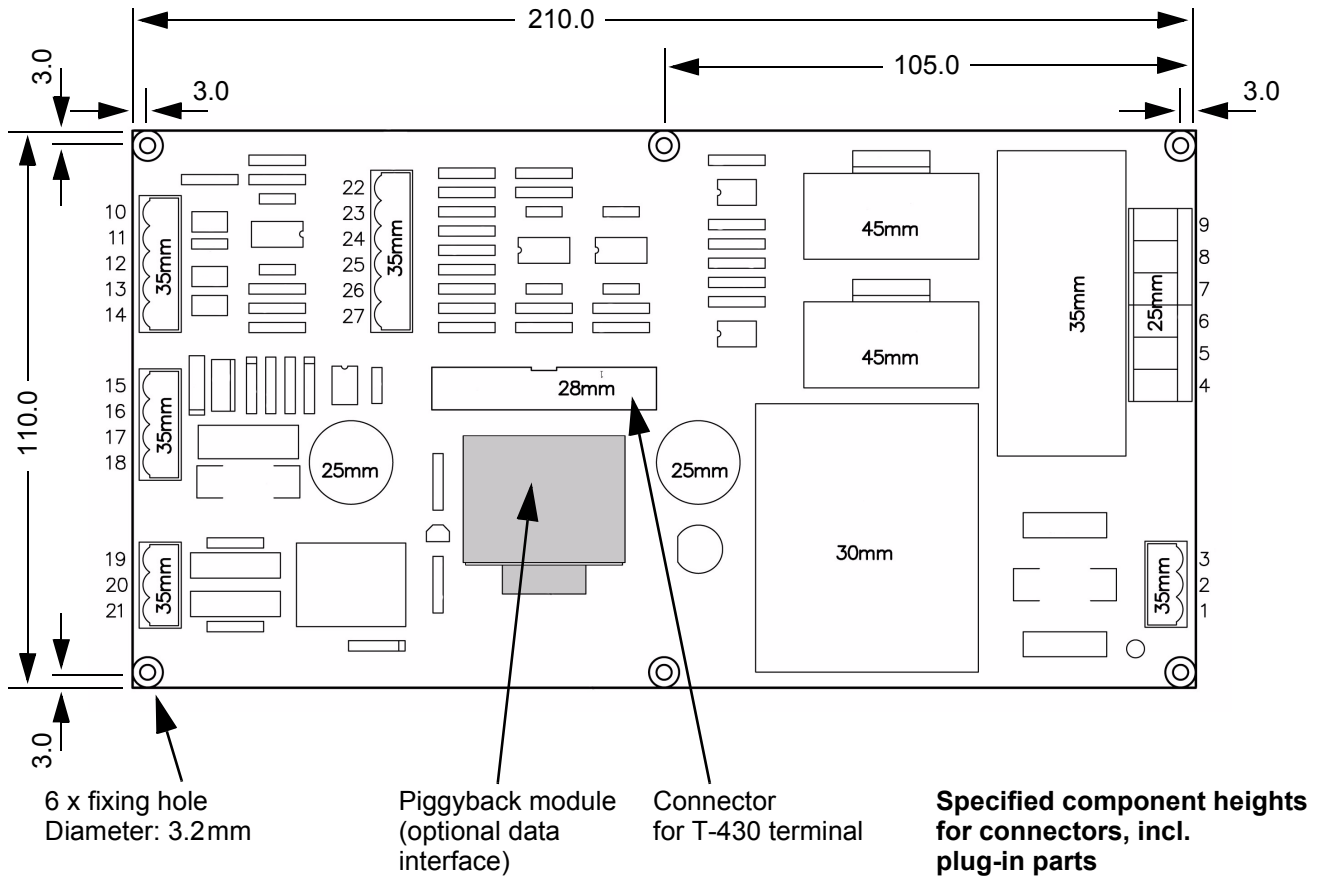

Spacing bolts with a minimum length of 6mm must be used to fasten the printed circuit board on the underside. All national and international regulations must be complied with.

7.2 Display terminal

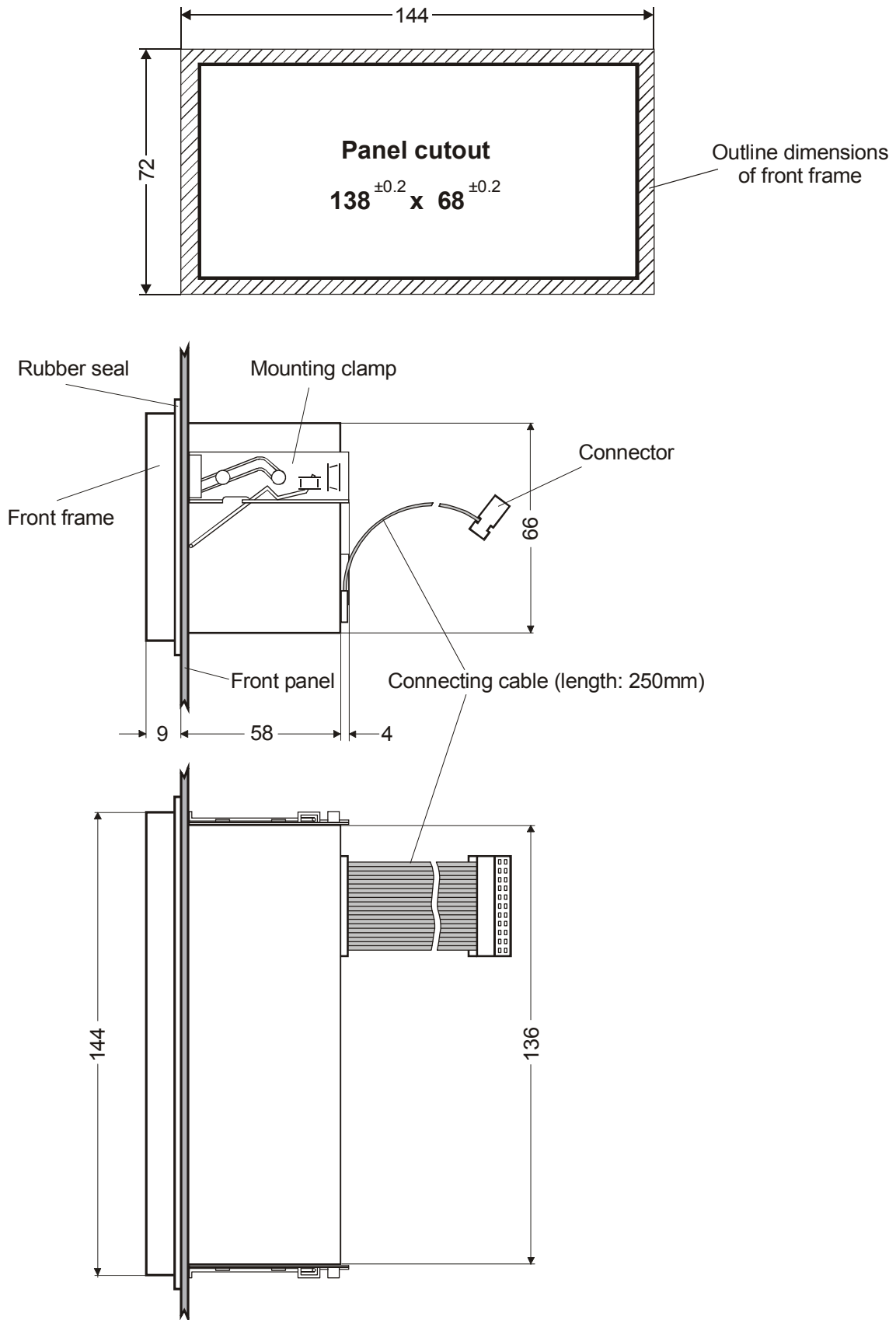

8 Installation

↪ See also section 2 „Application“ on page 4.

⚠ Installation and startup may only be performed by technically trained, skilled persons who are familiar with the associated risks and warranty provisions.

8.1 Installation procedure

Proceed as follows to install the RESISTRON temperature controller RES-430:

1. Switch off the line voltage and verify that all circuits are deenergized.
2. The supply voltage specified on the nameplate of the RESISTRON temperature controller must be identical to the line voltage that is present in the plant or machine. The line frequency is automatically detected by the temperature controller in the range from 47Hz to 63Hz.
3. Install the motherboard in the machine frame using the fixing screws.
4. Install the display terminal in the front panel cutout. It is fastened by means of two clamps which snap onto the side of the controller housing.
5. Wire the system in accordance with the instructions in section 6 „Technical data“ on page 8, section 8.4 „Wiring diagram with relay K1 (standard)“ on page 14 and the ROPEX Application Report. The information provided in section 8.2 „Installation steps“ on page 12 must be heeded additionally.

⚠ Check the tightness of all the system connections, including the terminals for the impulse transformer windings.

6. Make sure that the wiring conforms to the relevant national and international installation regulations.

8.2 Installation steps

The following points should be heeded in addition to the information provided in the ROPEX Application Report when installing the RES-430:

Wiring/cable cross-sections:

- Use the cable cross-sections indicated in the ROPEX Application Report. The cables between the RES-430 motherboard and the heatsealing band must not be longer than 1 m.
- Connect the heatsealing band directly to the RES-430. Additional clamping points can cause contact resistances, leading to temperature control errors.

⚠ The connecting cables between the motherboard and the heatsealing band must not be laid through closed steel sheets or pipes, in order to avoid temperature control errors. The permissible pipe and sheet materials are aluminum and plastic.

Impulse transformer:

- Specification as indicated in the ROPEX Application Report.

Heatsealing band/sealing bar:

- Use a heatsealing band with a suitable (positive) temperature coefficient.
- Copper the ends of the heatsealing band to prevent them from overheating.
- Push-on connectors on the sealing bar can lead to loose contacts. Use cables with screw connections.

8.3 Power supply

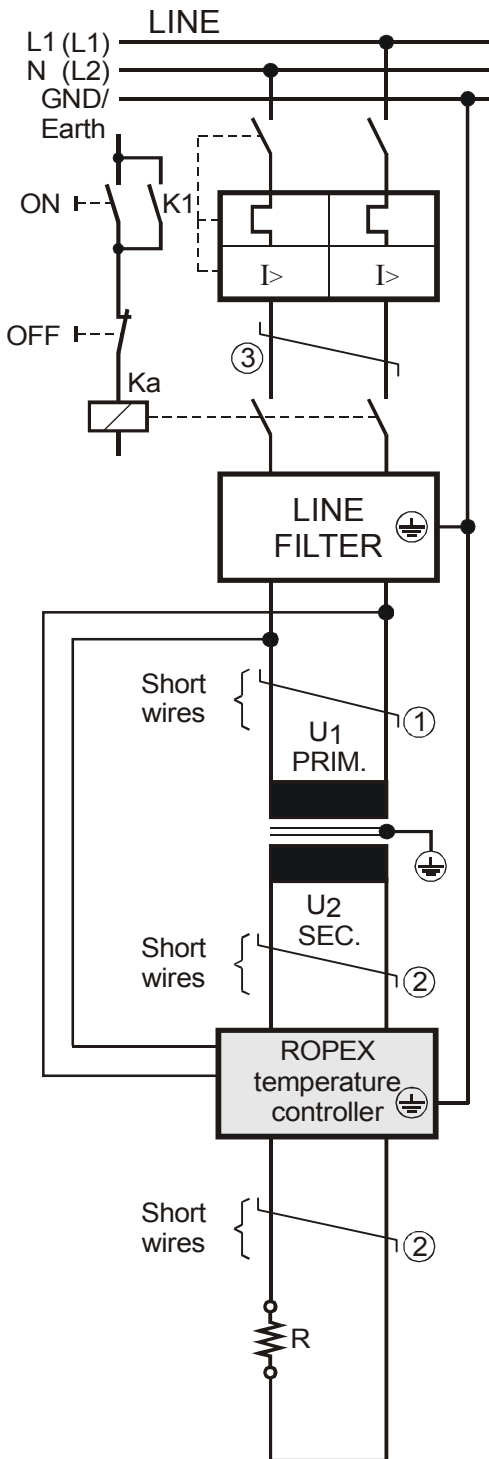

Line
115VAC, 230VAC

Circuit breaker
Double-pole, Z characteristic,
Rated current: 16A, e.g. ABB-STOTZ, Type S282-Z16 (for all applications)

⚠ Short-circuit protection only. RESISTRON temperature controller not protected.

Relay Ka
For "HEAT ON-OFF" function (all-pole) or "EMERGENCY STOP".

Line filter
The filter type and size must be determined according to the load, the transformer and the machine wiring (☞ ROPEX Application Report).

⚠ Do not lay the filter supply wires (line side) parallel to the filter output wires (load side).

Impulse transformer
Designed according to VDE 0570/EN 61558 (isolating transformer with reinforced insulation). Connect core to ground.

⚠ Use transformers with a one-section bobbin. The power, duty cycle and voltage values must be determined individually according to the application (☞ ROPEX Application Report and "Accessories" leaflet for impulse transformers).

RES-430 RESISTRON temperature controller

Wiring
The wire cross-sections depend on the application (☞ ROPEX Application Report).

Guide values:
Primary circuit: min. 1.0mm², max. 2.5mm²
Secondary circuit: min. 2.5mm², max. 4.0mm²

①②③ Twisting (>20/m) is recommended to improve EMC.

8.4 Wiring diagram with relay K1 (standard)

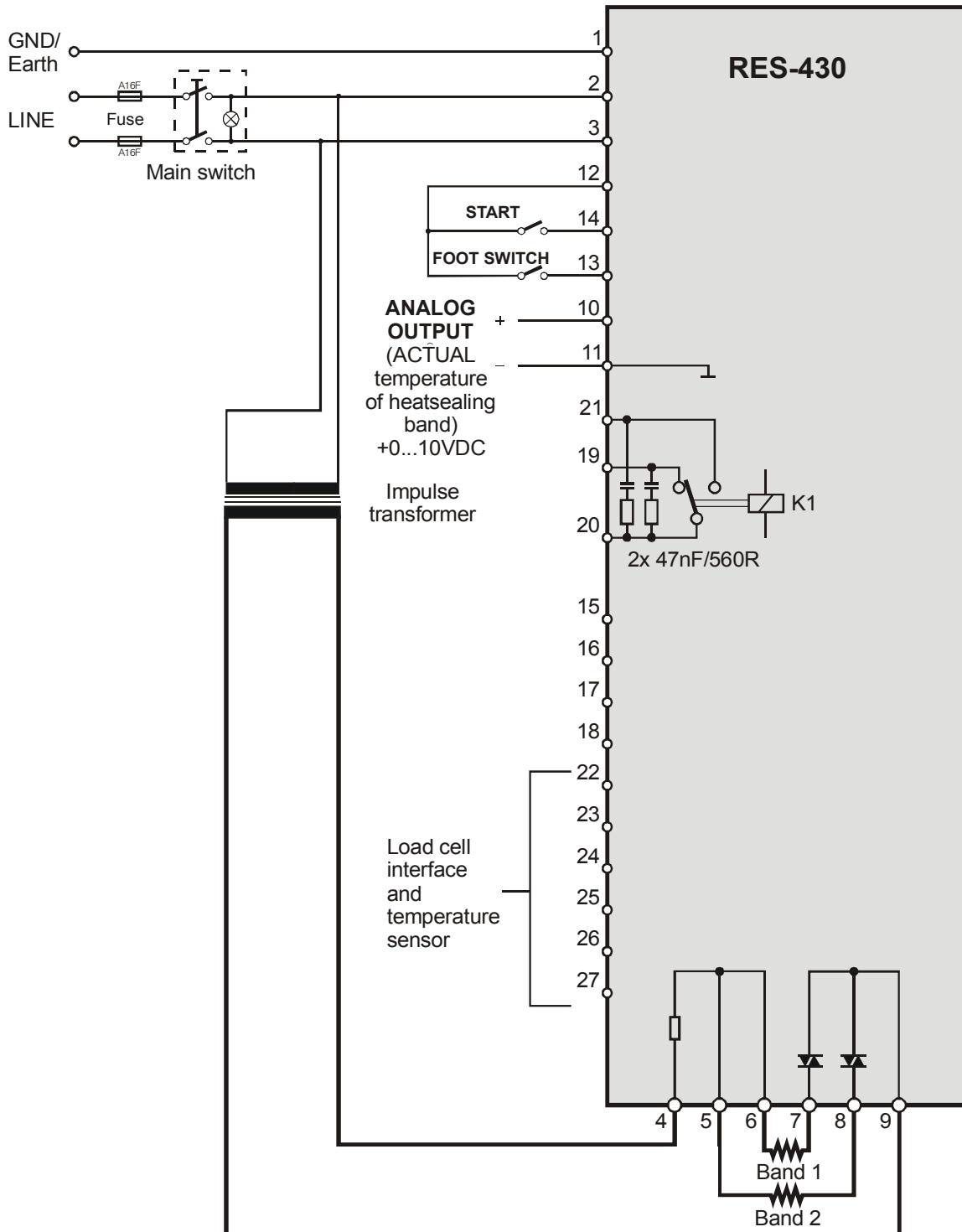

IMPORTANT:
 If only ONE heatsealing band is used, output terminals 7+8 must be jumped with a high current cable in order to avoid malfunctions or damage of the controller. Step 240 in the Configuration menu must be set to "Double" for this purpose.

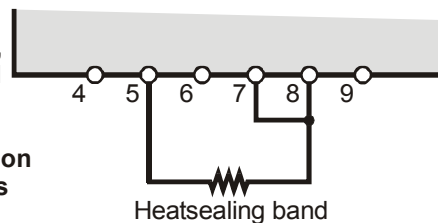

8.5 Wiring diagram with solenoid drive (optional)

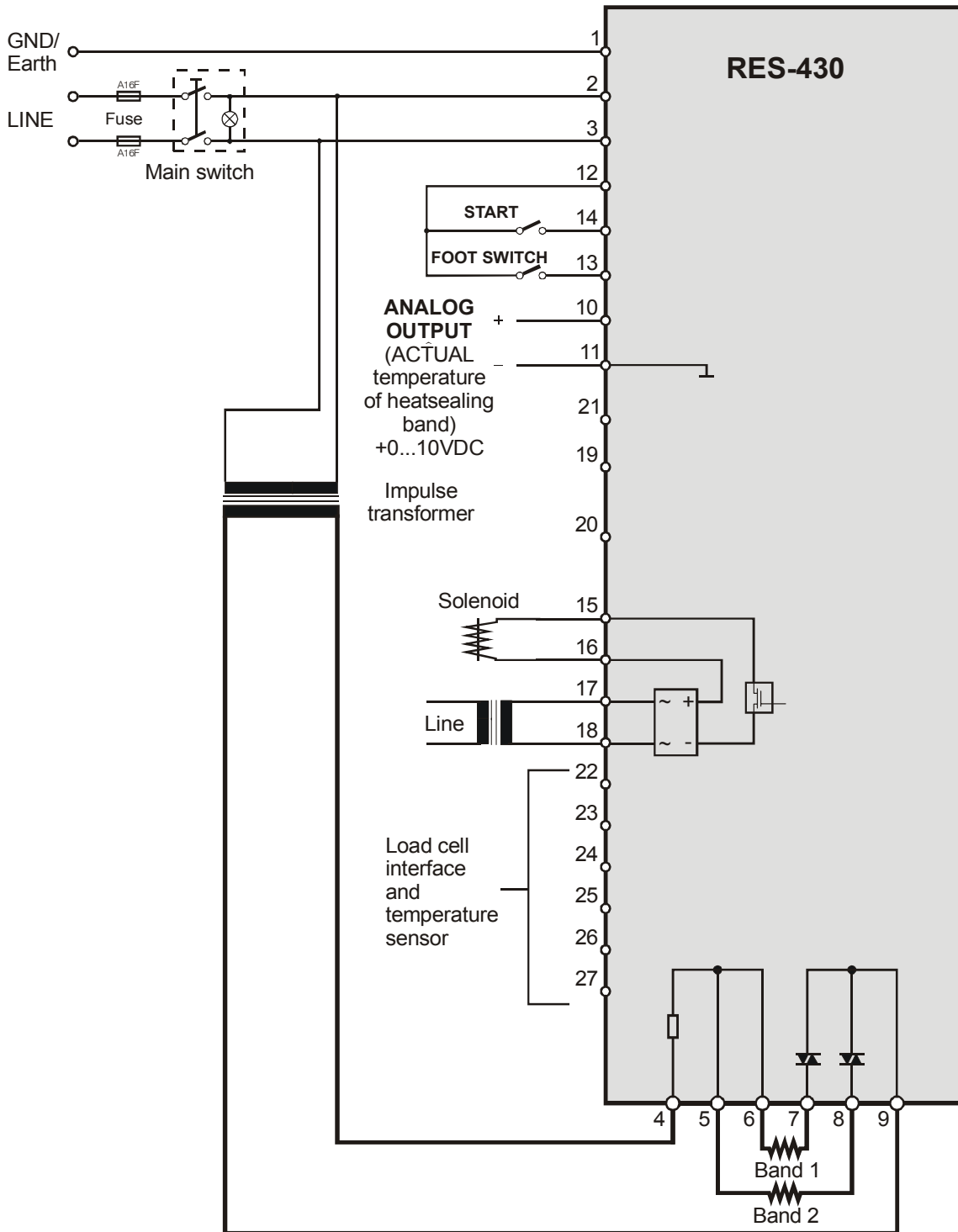

IMPORTANT:
 If only ONE heatsealing band is used, output terminals 7+8 must be jumped with a high current cable in order to avoid malfunctions or damage of the controller. Step 240 in the Configuration menu must be set to "Double" for this purpose.

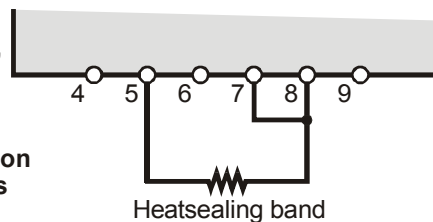

9 Startup and operation

9.1 View of the controller

9.1.1 Motherboard

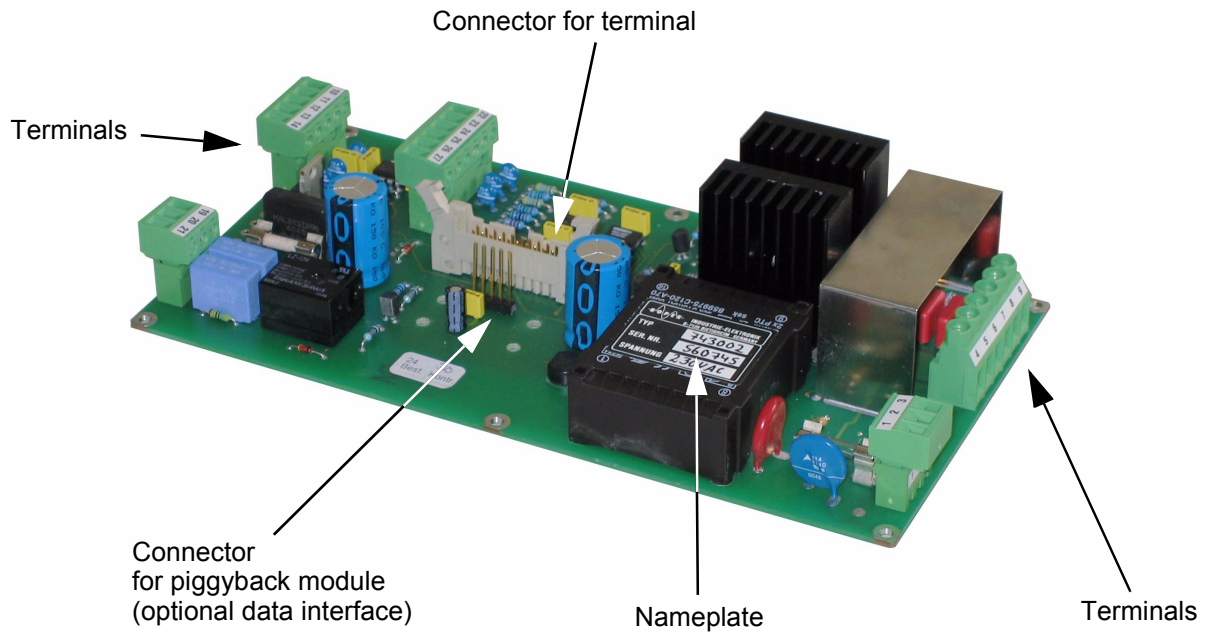

9.1.2 Front view of the terminal

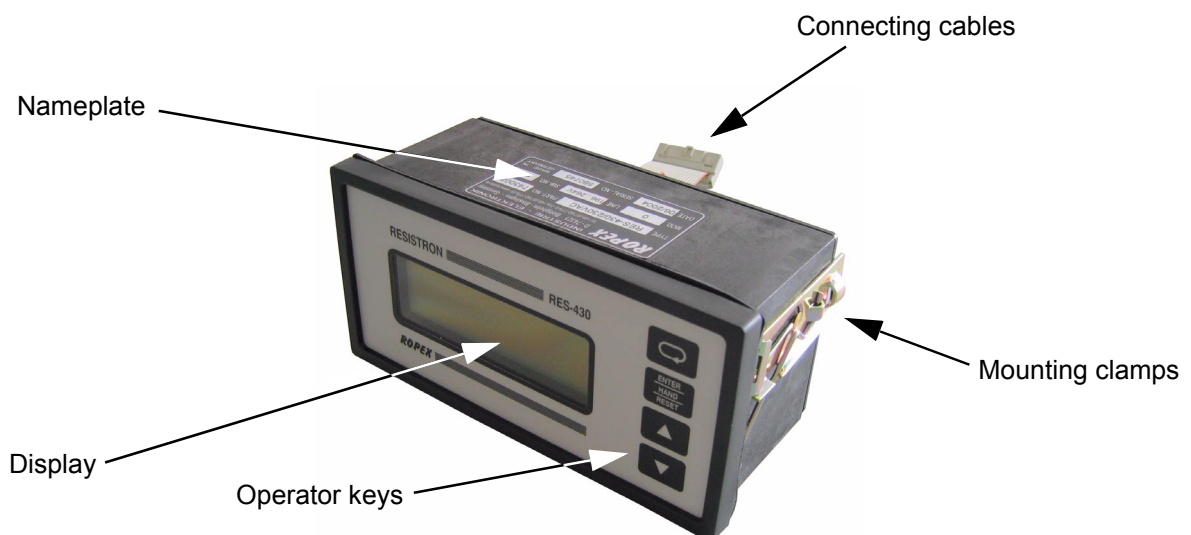

9.1.3 Rear view of the terminal

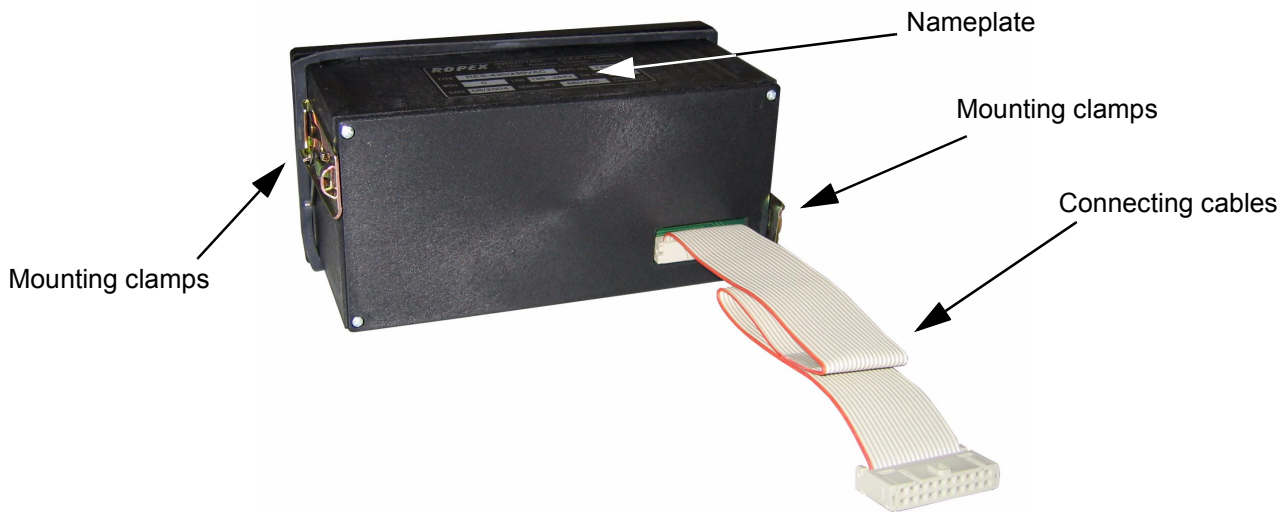

9.2 General controller configuration

The possible controller configurations are explained in the following sections. Proceed as described in section 9.7.1 "Initial startup" on page 25 to start up the controller for the first time.

! The menu step numbers indicated in the following are valid as of SW revision 007. Please refer to the reference table in section 10.4 "Menu structure" on page 31 for information about the numbers used for older controller versions.

9.2.1 Setting the language

The menu language can be changed on the controller without interrupting operation. It is set with step 201 in the Configuration menu:

The following settings are possible:
English, German, Italian

! The language which is selected in this menu remains set even if the factory settings are restored (step 202 in the Configuration menu).

9.2.2 Restoring the factory settings

The internal controller settings can be reset to the factory settings with step 202 in the Configuration menu. Only the language setting (step 201 in the Configuration menu) remains unchanged.

Please refer to section 11 "Factory settings" on page 46 for more information about the factory settings.

! If the controller settings are unknown when it is started up for the first time, the factory settings must be restored in order to prevent malfunctions.

9.2.3 Configuration of the alloy (temperature coefficient)

The heatsealing band alloy and the corresponding temperature coefficient are set with steps 203 and 204 in the Configuration menu:

You can select preset values for the alloy (or the temperature coefficient) with step 203:

1. **Temperature coefficient 780 ppm**
(e.g. Alloy-L)
2. **Temperature coefficient 1100 ppm (•)**
(e.g. Alloy-20)
3. **Temperature coefficient 1400 ppm**
(e.g. ROPEX CIRUS system)
4. **Temperature coefficient 1700 ppm**
(e.g. ROPEX CIRUS system)
5. **Temperature coefficient 3500 ppm**
(e.g. NOREX)
6. **"Variable" temperature coefficient**
Additional settings with step 204.

The temperature coefficient can be individually set with step 204 for your particular heatsealing band in the range from 400 to 4000 ppm.

(•) Factory setting

! Menu step 204 is only available if you selected "Variable" with step 203.

9.2.4 Configuration of the temperature range

The temperature range for the controller can be set with step 205 in the Configuration menu. You can select a temperature range of 200°C, 300°C (•), 400°C or 500°C.

9.3 Time control (timer function)

9.3.1 Activation and indication

! The settings described here are only allowed to be entered by technically trained persons. An incorrectly parameterized timer function may cause disruptions to operation and damage to the machine.

The timer function is always active and cannot be switched off. The internal timeout is started by activating the "START" signal. The "START" signal must remain activated until the end of the parameterized cooling phase. If the "START" signal is deactivated before the end of the cooling phase, the timeout is interrupted.

If time control is on, activating the "START" signal starts the internally parameterized timeout. This timeout comprises:

- Starting delay (delay at the beginning of the heating phase)
- Heating phase (heating and control process)
- Cooling phase
- Relay K1 or optional solenoid drive function

! It is only possible to start a heating process with the "HAND" key on the controller. The timeout of the internal time control cannot be started with this key.

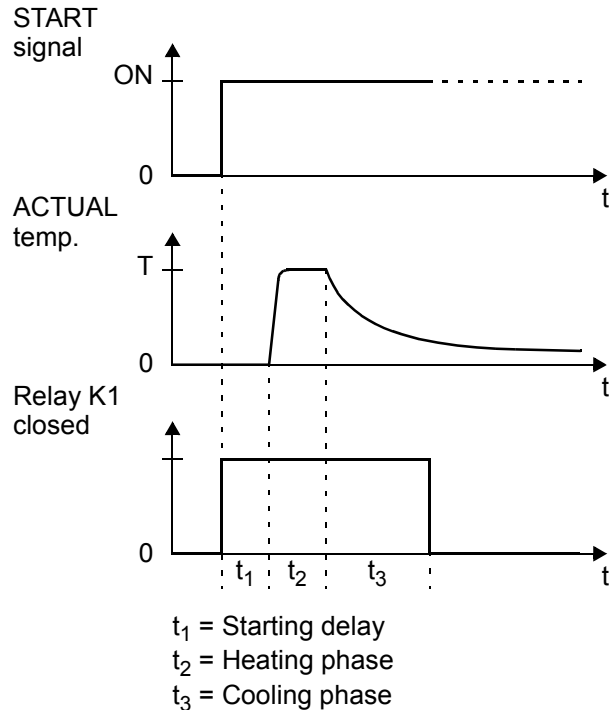

! The timeout of the internal time control (timer function) can only be interrupted by switching off the controller or by deactivating the "START" signal.

If the display is in the home position, the individual timeouts can be monitored there.

The remaining heatsealing time is indicated on the display in the form of a countdown at the end of the heating phase. A direction arrow indicates the active process.



The active cooling phase is subsequently marked with the direction arrow at the end of the heating phase.



(•) Factory setting

The direction arrow disappears again at the end of the cooling phase (i.e. at the end of the internal timeout). The current condition of relay K1 (or the optional solenoid drive) is indicated by means of a separate icon. If the icon is visible, the normally open contact of the relay is closed or the solenoid drive is active.

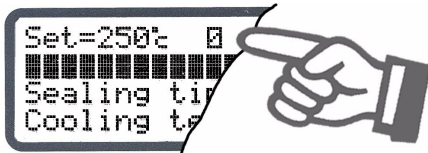

Separate settings can be entered for the individual timeouts. These settings are possible with steps 103, 104 and 105 in the Settings menu and with steps 210, 211 and 212 in the Configuration menu.

The options available with these advanced settings are described below.

9.3.2 Setting the starting delay

The start of the heating process can be explicitly delayed by entering a starting delay time with step 103 in the Settings menu, e.g. in order to bridge the closing time of the heatsealing bars.

When the "START" signal is activated, the controller waits for the time specified with this menu step to elapse before commencing the heating process.

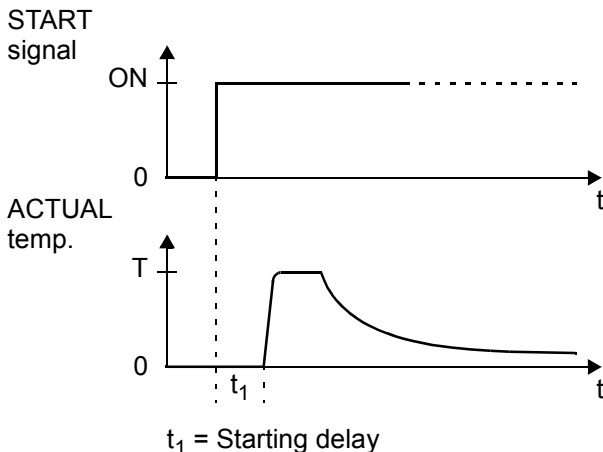

The starting delay can be set in the range from 0 to 9.9s. A delay of 0s is defined as the factory setting. In this case, the heating process begins as soon as the "START" signal is activated.

9.3.3 Setting the heatsealing time

The heatsealing time can be set in the range from 0 to 99.9s with step 104 in the Settings menu. The factory setting is 1.0s.

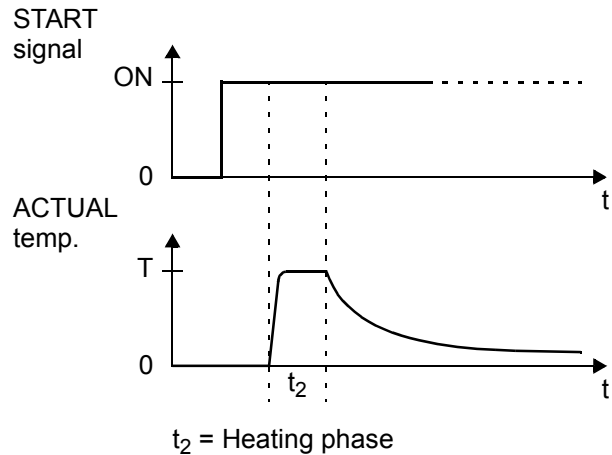

9.3.4 Setting the cooling mode

Various criteria for the end of the cooling phase can be specified with step 210 in the Configuration menu of the RES-430 controller:

The possible settings are as follows:

1. "Absolute" (•)

The cooling phase ends when the ACTUAL temperature of the heatsealing band falls below a specified temperature value T_K . This cooling temperature can be set with step 105 in the Settings menu.

2. "Relative"

The cooling phase ends when the ACTUAL temperature falls to a value corresponding to X% of the SET temperature. This percentage cooling value can be set with step 105 in the Settings menu. Example:

SET temperature = 180°C, cooling value = 60%
 → Cooling phase ends when ACTUAL temperature ≤ 108°C

3. "Time"

The cooling phase ends after a specified time in seconds and is independent of the ACTUAL temperature. This cooling time can be set with step 105 in the Settings menu.

(•) Factory setting

The various cooling modes are shown below:

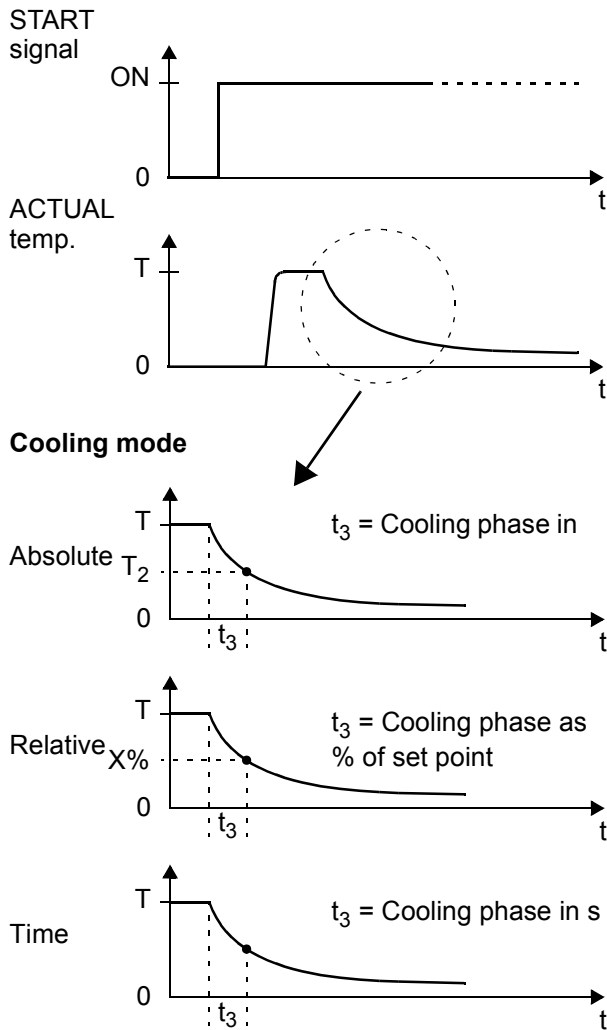

9.3.5 Setting the cooling value

After the cooling phase has been configured with step 210 in the Configuration menu (↪ section 9.3.4 "Setting the cooling mode" on page 19), you can specify the cooling parameters with step 105 in the Settings menu.

⚠ The options available with step 105 in the Settings menu vary according to the selection made with step 210 in the Configuration menu. All settings entered with menu step 105 are overwritten if step 210 is changed subsequently.

The possible settings are as follows:

1. **"Cooling temp. in °C"**
(if setting with menu step 210 = "Absolute")
 The cooling phase of the internal timeout ends when the ACTUAL temperature of the heatsealing band falls below the SET temperature.
 The minimum settable temperature is 50°C. This is also the factory setting.
- ⚠ The maximum value of the setting range is limited either by the maximum value specified with step 206 in the Configuration menu or by the temperature range set with step 205.**
2. **"Cooling temp. in %"**
(if setting with menu step 210 = "Relative")
 The cooling phase of the internal timeout ends when the ACTUAL temperature falls to the specified percentage of the SET temperature. This value can be set between 40 and 100%.
 The factory setting is 40%.
3. **"Cooling time in s"**
(if setting with menu step 210 = "Time")
 The cooling phase ends when the specified time elapses. This time can be set between 0 and 99.9s.
 The factory setting is 10.0s.

9.3.6 Setting the start of the heatsealing time

The start condition for the set heatsealing time (step 104 in the Settings menu) can be specified with step 211 in the Configuration menu.

The following settings are possible:

1. **"When heating starts"**
 The parameterized heatsealing time starts as soon as the set starting delay elapses (↪ Settings menu, step 103).
 If the starting delay = 0s, the heatsealing time begins as soon as the "START" signal is activated.
2. **"When temperature reached" (•)**
 Once again, the heating process starts as soon as the set starting delay elapses (↪ Settings menu, step 103). The specified heatsealing time does not start, however, until the ACTUAL temperature of the heatsealing band reaches 95% of the SET temperature.

(•) Factory setting

These two alternatives are shown below:

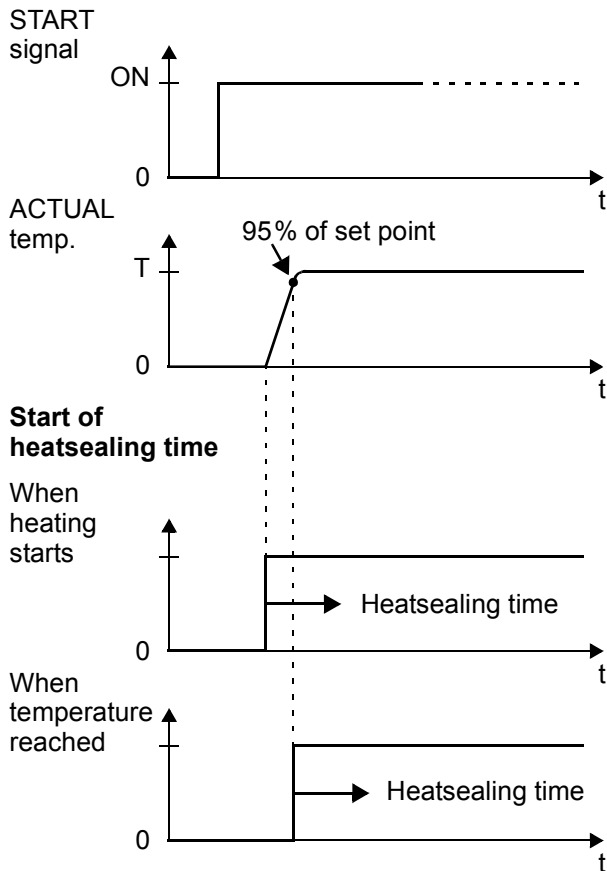

9.3.7 Relay K1 / solenoid drive (optional)

The function of relay K1 (or the optional solenoid drive) is specified with step 212 in the Configuration menu. The settings can be selected as follows (as of SW revision 007):

1. **"When start signal present" (*)**

The normally open contact of relay K1 (or the

(*) Factory setting

solenoid drive) closes as soon as the "START" signal is activated and remains closed until the end of the parameterized timeout (i.e. until the end of the cooling phase).

2. **"When temperature reached"**

The normally open contact of relay K1 (or the solenoid drive) closes when the ACTUAL temperature reaches 95% of the SET temperature and remains closed until the end of the parameterized timeout (i.e. until the end of the cooling phase).

3. **"While cooling"**

The normally open contact of relay K1 (or the solenoid drive) closes at the end of the heating phase and opens again at the end of the cooling phase.

This configuration permits air cooling to be activated with relay K1 (or the solenoid drive) during the cooling phase, for instance.

4. **"End-of-cycle impulse"**

The normally open contact of relay K1 (or the solenoid drive) closes at the end of the parameterized timeout (i.e. at the end of the cooling phase) and opens again after approximately 500ms. If a "START" signal is activated while relay K1 is still closed (or the solenoid drive is active), the relay opens again immediately.

5. **"OFF"**

Relay K1 (or the solenoid drive) is deenergized, i.e. it has no function.

⚠ As of SW revision 008, relay K1 (or the solenoid drive) cannot be re-energized for 200ms after the end of the parameterized cooling phase, in order to prevent bouncing or oscillation of the driven closing movement.

The possible settings are shown below:

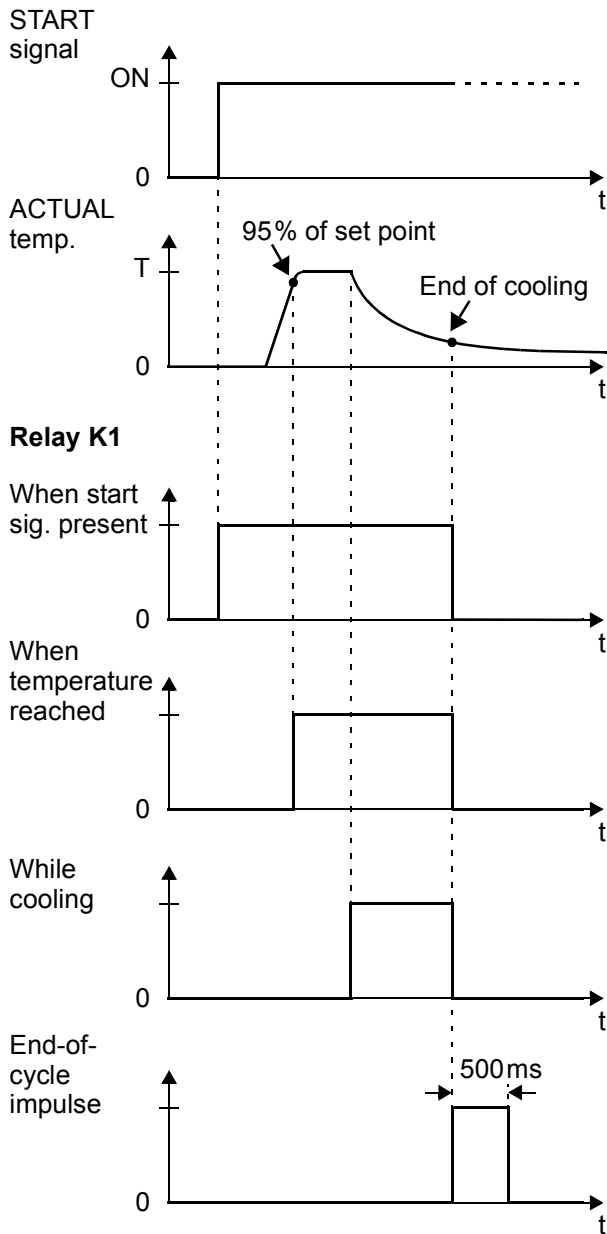

⚠ Other names are used for the settings up to SW revision 006. The only possible settings are "ON", "When START signal present" and "OFF".

9.4 Temperature diagnosis

(As of SW revision 007)

The RES-430 checks during the heatsealing phase whether the ACTUAL temperature is within a settable tolerance band ("OK" window) on either side of the SET temperature. The lower ($\Delta\vartheta_{low}$) and upper ($\Delta\vartheta_{high}$) limits of the tolerance band can be changed by means of steps 207+208 in the Configuration menu.

If the actual temperature is outside the specified tolerance during the parameterized monitoring time, the heatsealing cycle is immediately interrupted and an alarm is indicated on the display.

This monitoring function serves to maintain a constant temperature.

SW revision 007:

The temperature diagnosis function is always active. The diagnosis begins if the ACTUAL temperature exceeds the lower tolerance limit and simultaneously corresponds to 95% of the SET temperature. The diagnosis ends at the end of the parameterized heatsealing phase.

As of SW revision 008:

The temperature diagnosis function can be activated and deactivated with step 217 in the Configuration menu. The following settings are possible:

- "OFF" (•)**
Temperature diagnosis deactivated
- "ON"**
Temperature diagnosis activated

If the temperature diagnosis function is activated, an additional delay time between 0 and 9.9s can be parameterized for temperature monitoring with step 218 in the Configuration menu. This delay time starts when the ACTUAL temperature reaches 95% of the SET temperature. The temperature diagnosis function is activated as soon as the delay time elapses (in the case of SW revision 008, the ACTUAL temperature must also have exceeded the lower limit of the tolerance band in order for the diagnosis function to be activated).

The temperature diagnosis function can thus be explicitly deactivated during the closing movement of the sealing jaws, for instance.

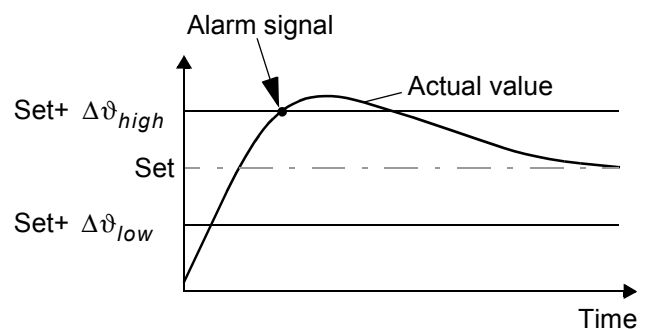

(•) Factory setting

9.5 Load cell interface / temperature sensor

9.5.1 General

The RES-430 controller can be connected to a load cell and a temperature sensor. The load cell is used to measure the closing force of the heatsealing mechanism. This force can be monitored by the controller during the heatsealing cycle. If the closing pressure is outside the specified limit values, the heatsealing cycle is interrupted and an alarm is indicated on the display.

The temperature sensor can be used to monitor either the internal machine/equipment temperature or the temperature of the load cell. An alarm is output by the controller if the maximum permissible temperature is exceeded.

The settings for the load cell interface and the temperature sensor can be selected as follows with step 241 in the Configuration menu:

1. **"OFF" (•)**
Load cell interface and temperature sensor not active
2. **"Force"**
Load cell interface for force measurement active, temperature sensor not active
3. **"Temperature"**
Temperature sensor active, load cell interface not active
4. **"Temperature and force"**
Load cell interface for force measurement and temperature sensor active

 **The menu steps 242 to 246 described below are accessible if step 241 is set accordingly.**

9.5.2 Force diagnosis

The RES-430 checks during the heatsealing phase (assuming this has been activated with step 241) whether the measured force of the connected load cell is inside a settable tolerance band ("OK window"). The upper and lower limit values can be changed

(•) Factory setting

separately by means of steps 242+243 in the Configuration menu.

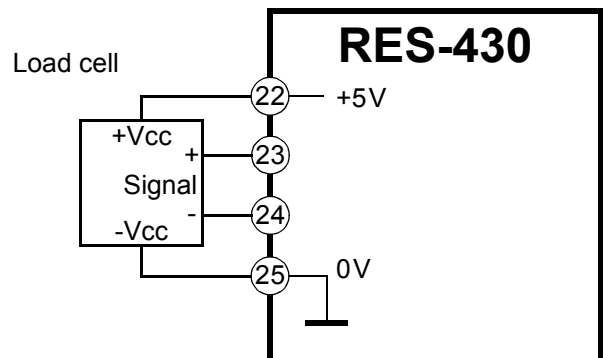

If the measured force is outside the specified tolerance during the parameterized monitoring time, the heatsealing cycle is immediately interrupted and an alarm is indicated on the display.

This monitoring function serves, among other things, to ensure a constant closing force of the sealing jaws.

Up to SW revision 007:

The force diagnosis begins 100ms after the ACTUAL temperature reaches 95% of the SET temperature and continues until the end of the parameterized cooling phase.

As of SW revision 008:

The force diagnosis function can be additionally parameterized by means of step 247 in the configuration menu. The following settings are possible:

1. **"OFF" (•)**
Force diagnosis deactivated
2. **"Active during heatsealing cycle"**
The force diagnosis is permanently active during the heatsealing phase until the end of the parameterized cooling phase. If this setting is activated, an additional delay time between 0 and 9.9s can be parameterized with step 248 in the Configuration menu. This delay time starts when the ACTUAL temperature reaches 95% of the SET temperature. The force diagnosis function is activated as soon as the delay time elapses.
The force diagnosis function can thus be explicitly deactivated during the closing movement of the sealing jaws, for instance.
3. **"End of heating phase"**
A single force diagnosis takes place at the end of the heatsealing phase.

4. "End of cooling phase"

A single force diagnosis takes place at the end of the cooling phase.

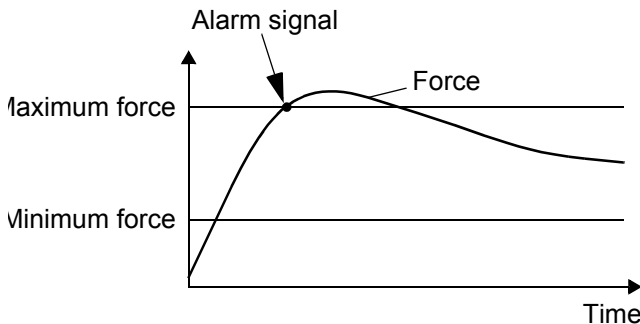

immediately output by the controller if this maximum temperature is exceeded.

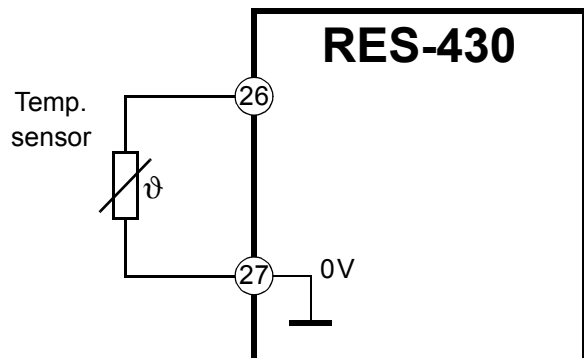

9.5.3 Calibration of the load cell interface

The integrated load cell must be calibrated to the specifics of each machine when the controller is started up. The necessary values can be entered with steps 244+245.

The load cell can be tared with step 244 when it is off-load. After loading the cell with a defined, known weight, the associated reference force must be entered with step 245. A straight force measurement curve is assumed between these two measuring points (tare weight and reference force).

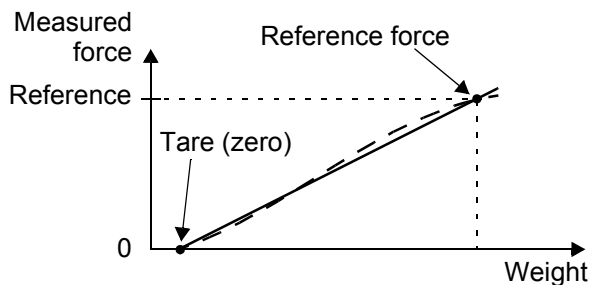

If a heatsealing cycle is in progress, it is interrupted. The temperature monitoring function is activated 3s after the controller is switched on.

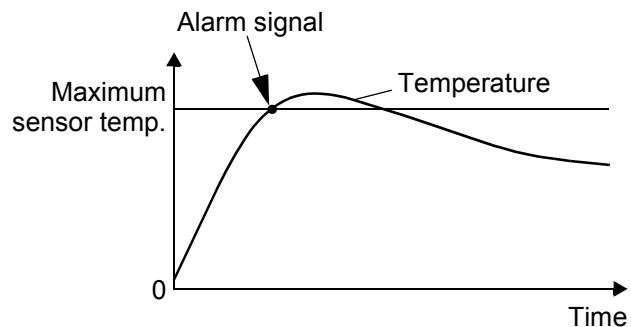

If a temperature sensor is not connected (or if the sensor connecting cable is defective), an alarm is output by the controller after 3s (assuming the temperature sensor has been activated with step 241).

⚠ The sensor temperature measurement described here serves to monitor and/or limit the load cell or machine temperature. It cannot be used to monitor the temperature of the heatsealing band or for temperature control.

9.5.4 Temperature sensor

The maximum permissible temperature of the sensor can be set with step 246 (assuming the temperature sensor has been activated with step 241). An alarm is

9.6 Heatsealing band

9.6.1 General

The heatsealing band is a key component in the control loop, since it is both a heating element and a sensor. The geometry of the heatsealing band is too complex to be discussed at length here. We shall therefore only refer to a few of the most important physical and electrical properties:

The measuring principle applied for this system necessitates a heatsealing band alloy with a suitable temperature coefficient TCR, i.e. one whose resistance increases as the temperature rises.

Too low a TCR leads to oscillation or uncontrolled heating.

When heatsealing bands with a higher TCR are used, the controller must be calibrated for this.

The first time the heatsealing band is heated to approximately 200...250°C, the standard alloy undergoes a once-only resistance change (burn-in effect). The cold resistance of the heatsealing band is reduced by approximately 2...3%. However, this at first glance slight resistance change results in a zero point error of 20...30°C. The zero point must therefore be corrected after a few heating cycles (↪ section 9.6.2 "Burning in the heatsealing band" on page 25).

One very important design feature is the copper or silver-plating of the heatsealing band ends. Cold ends allow the temperature to be controlled accurately and increase the life of the teflon coating and the heatsealing band.

! An overheated or burned-out heatsealing band must no longer be used because the TCR has been altered irreversibly.

9.6.2 Burning in the heatsealing band

If a new heatsealing band has been used, the zero point is first of all calibrated while the band is still cold by activating the "AUTOCAL" function on the controller. When the "AUTOCAL" function has finished, the display shows the preselected calibration temperature (default value: 20°C). Adjust the set point to approximately 250°C and press the "HAND" key (display in home position) to activate the "START" signal and heat for approximately 1 second. After recooling, the controller usually indicates a value less than 20°C. Repeat the "AUTOCAL" function. The heatsealing band has now been burned in and the change in the alloying properties stabilized.

The burn-in effect described here does not occur if the heatsealing band has already been thermally pretreated by the manufacturer.

9.6.3 Replacing the heatsealing band

All power supply leads must be disconnected from the RESISTRON temperature controller in order to replace the heatsealing band.

! The heatsealing band must be replaced in accordance with the instructions provided by the manufacturer.

Each time the heatsealing band is replaced, the zero point must be calibrated with the AUTOCAL function while the band is still cold, in order to compensate production-related resistance tolerances. The burn-in procedure described above must be performed for all new heatsealing bands.

9.7 Startup procedure

Please also refer to section 2 "Application" on page 4.

! Installation and startup may only be performed by technically trained, skilled persons who are familiar with the associated risks and warranty provisions.

9.7.1 Initial startup

Prerequisites: The controller must be correctly installed and connected (↪ section 8 "Installation" on page 12). The possible settings are described in detail in section 9.2 "General controller configuration" on page 17 and section 10 "Controller functions" on page 27.

The essential controller configurations are described below:

1. Switch off the line voltage and verify that all circuits are deenergized.
2. The supply voltage specified on the nameplate of the controller must be identical to the line voltage that is present in the plant or machine. The line frequency is automatically detected by the temperature controller in the range from 47 to 63Hz.
3. Heed the information contained in the ROPEX Application Report as well as the specifications for the heatsealing band that is used (section 9.2 "General controller configuration" on page 17).
4. Make sure that a START signal is not present.
5. Switch on the line voltage.
6. A power-up message appears on the display for approximately 2 seconds when the controller is switched on to indicate that it has been started up correctly.

7. One of the following states then appears:

DISPLAY	ACTION
Display in home position	Go to 8
Alarm signal with error codes 104...106, 111...113, 211, 302, 303	Go to 8
Alarm signal with error codes 101...103, 107, 108, 201...203, 801, 9xx	Fault diagnosis (↪ section 10.1 9)

8. Set the controller configuration as described in section 9.2 "General controller configuration" on page 17. The following settings are always required:

Setting	Step in Configuration menu
Language	201
Restore factory settings	202
Heatsealing band alloy	203, 204
Temperature range	205
Single/double sealing	240

9. Activate the AUTOCAL function while the heatsealing band is still cold (with step 107 in the Settings menu). The progress of the calibration process is indicated by a counter on the display (approx. 10...15 s). A voltage of 0VDC appears at the same time at the actual value output (terminals 10+11). If an ATR-x is connected, it indicates 0°C. When the zero point has been calibrated, the display is reset to the home position and the previously set AUTOCAL temperature is indicated (default: 20°C). A voltage of 0.66VDC (200°C and

300°C ranges) or 0.4VDC (400°C and 500°C ranges) appears at the actual value output at 20°C. If an ATR-x is connected, it must be set to "Z" (20°C).

If the zero has not been calibrated successfully, an alarm signal indicates error codes 111, 114, 211. In this case the controller configuration is incorrect (↪ section 9.2 "General controller configuration" on page 17 and ROPEX Application Report). Repeat the zero point calibration after the controller has been configured correctly.

10. When the zero point has been calibrated successfully, the main menu appears on the display again. Then specify a defined temperature (heatsealing temperature) with step 101 in the Settings menu and activate the "START" signal (HEAT). Alternatively, you can start a heatsealing process by pressing the "HAND" key (assuming step 213 has not been locked in the Configuration menu and the display is in the home position). The indication of the ACTUAL temperature on the display (digital value and dynamic bar) permits the heating and control process to be monitored:

The controller is functioning correctly if the temperature indicated on the display has a continuous curve, in other words it must not jump abruptly, fluctuate or deviate temporarily in the wrong direction).

If an error code is displayed, please proceed as described in section 10.19 "Error messages" on page 42.

11. Burn in the heatsealing band (↪ section 9.6 "Heatsealing band" on page 24) and repeat the AUTOCAL function.

The controller is now ready

9.7.2 Restart after replacing the heatsealing band

To replace the heatsealing band, proceed as described in section 9.6 "Heatsealing band" on page 24.

 **Always use a heatsealing band with the correct alloy, dimensions and copper-plating in order to avoid malfunctions and overheating.**

Continue with section 9.7.1, steps 9 and 10.

10 Controller functions

See also section 8.4 "Wiring diagram with relay K1 (standard)" on page 14.

! The menu step numbers indicated in the following are valid as of SW revision 007. Please refer to the reference table in section 10.4 "Menu structure" on page 31 for information about the numbers used for older controller versions.

10.1 Indicators and controls

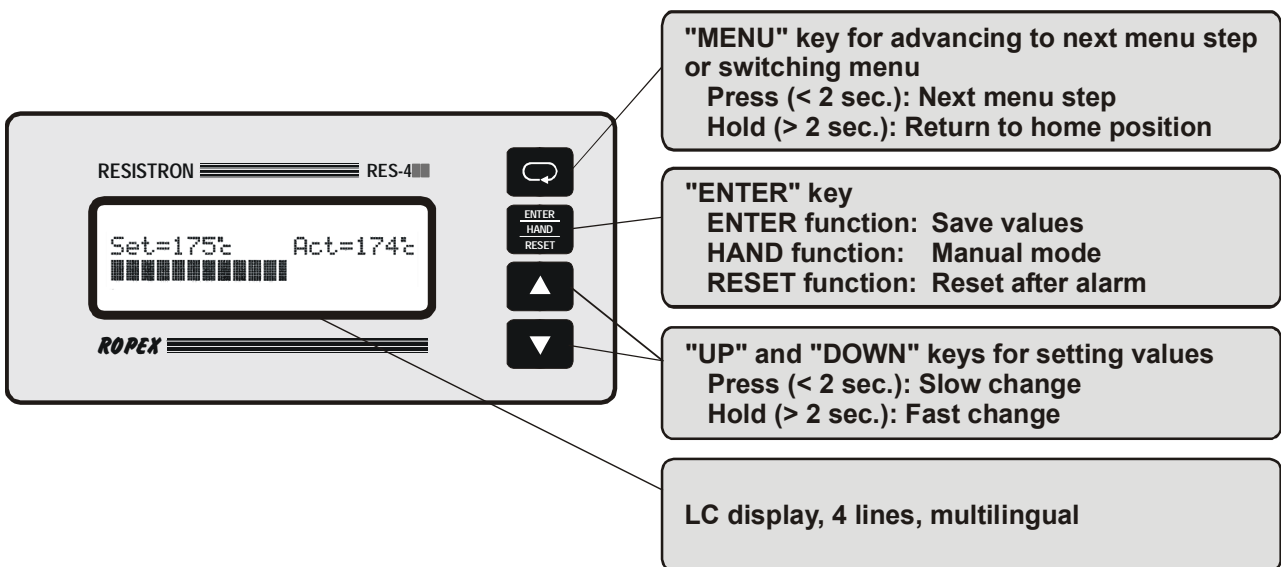

10.2 Display

switched on. This message also includes details of the software version.

10.2.1 Power-up message

A power-up message appears on the display for approximately 2 seconds when the controller is

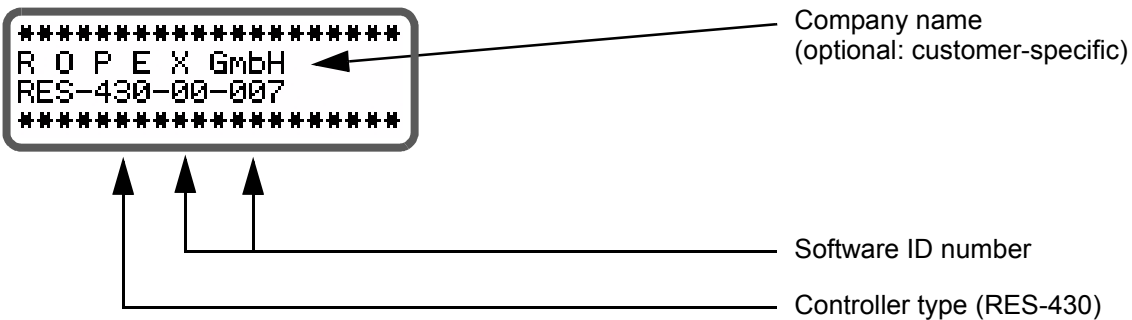

10.2.2 Display in home position

If no settings are entered on the controller and no alarm signals are present, the display is in the home position,

in other words it indicates the SET temperature as a digital value and the ACTUAL temperature as a digital value and a dynamic bar.

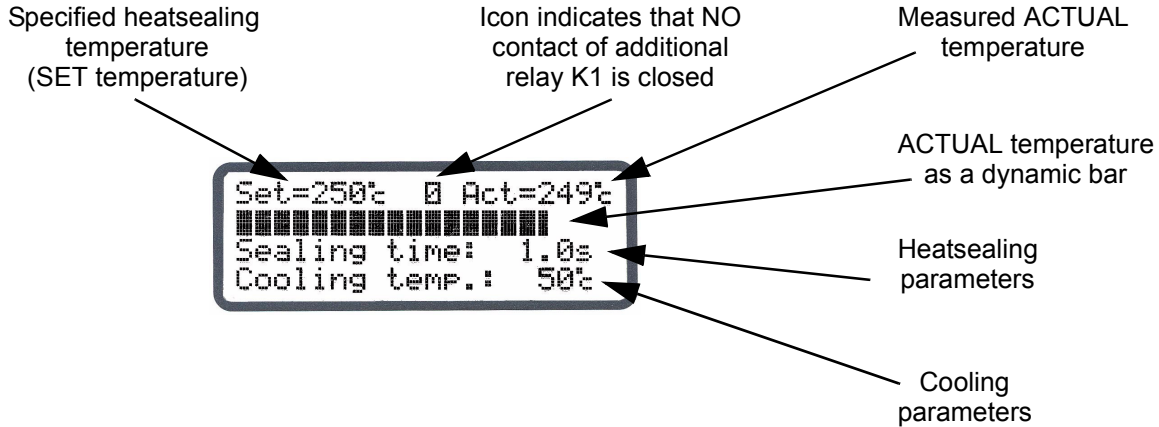

10.2.3 Settings/Configuration menus

The required parameters are set on two menu levels: the Settings (control) menu and the Configuration menu (↪ section 10.4 "Menu structure" on page 31).

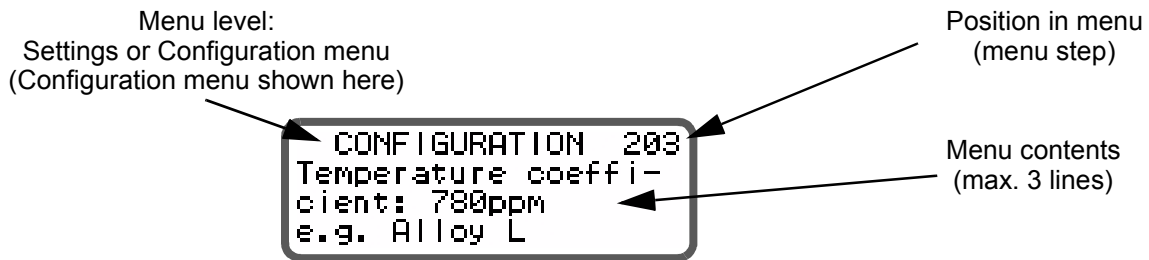

10.2.4 Alarm signals

The fault diagnosis function of the controller is always active. If a fault is detected, it is indicated on the display

immediately in the form of an alarm signal (↪ section 10.18 "System monitoring / alarm output" on page 42).



10.3 Navigation in the menus

10.3.1 Navigation in menus without an alarm

A "MENU" key is provided for navigating through the various menu steps and levels. By pressing this key briefly (<2s) at any time, you can jump to the next menu step. By pressing the key for longer (>2s), you can return to the home position from anywhere in the menu

structure, providing a controller alarm is not active. In this case, the Alarm menu is opened instead.

If the display is in the home position or an alarm is indicated and you press the "MENU" key for longer than 2s, you are taken directly to the configuration level (starting at step 201).

In addition, you always return to the home position if you do not press any keys for a period of 30s. There is no automatic return after 30s from "AUTOCAL" or "Alarm".

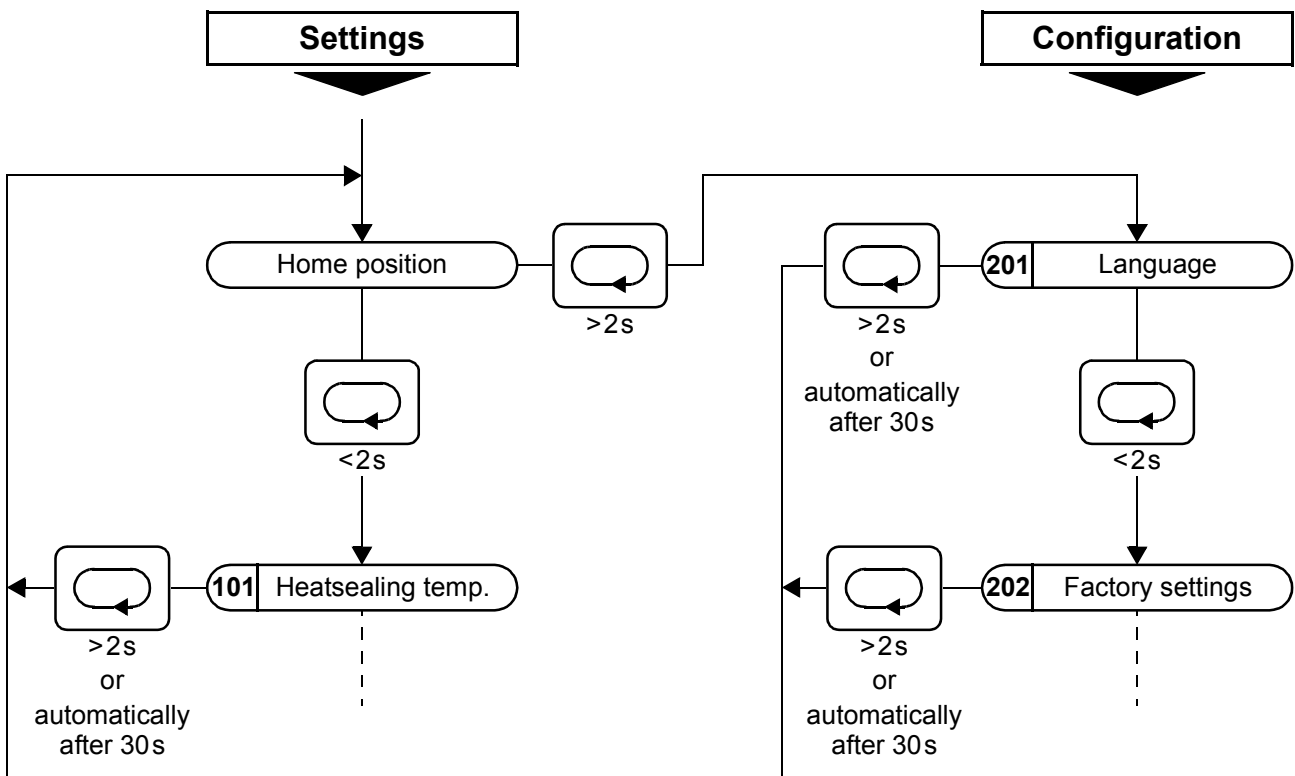

10.3.2 Navigation in menus with an alarm

If an alarm is signaled, the controller switches to the Alarm menu. Some faults can be acknowledged by pressing the "RESET" key (↵ section 10.18 "System monitoring / alarm output" on page 42). In this case, the controller switches back to the home position.

If the fault can be rectified by executing the AUTOCAL function, you can select the "AUTOCAL" menu step directly by briefly pressing the "MENU" key (<2s). You

can then activate the "AUTOCAL" function by pressing the "ENTER" key (↵ section 10.8 "Automatic zero calibration (AUTOCAL)" on page 35).

If you press the "MENU" key for longer than 2s in the Alarm menu, you are taken directly to the configuration level (starting at step 201). You can return from the Configuration menu to the Alarm menu either by pressing the "MENU" key for longer than 2s or by not pressing any keys for 30s.

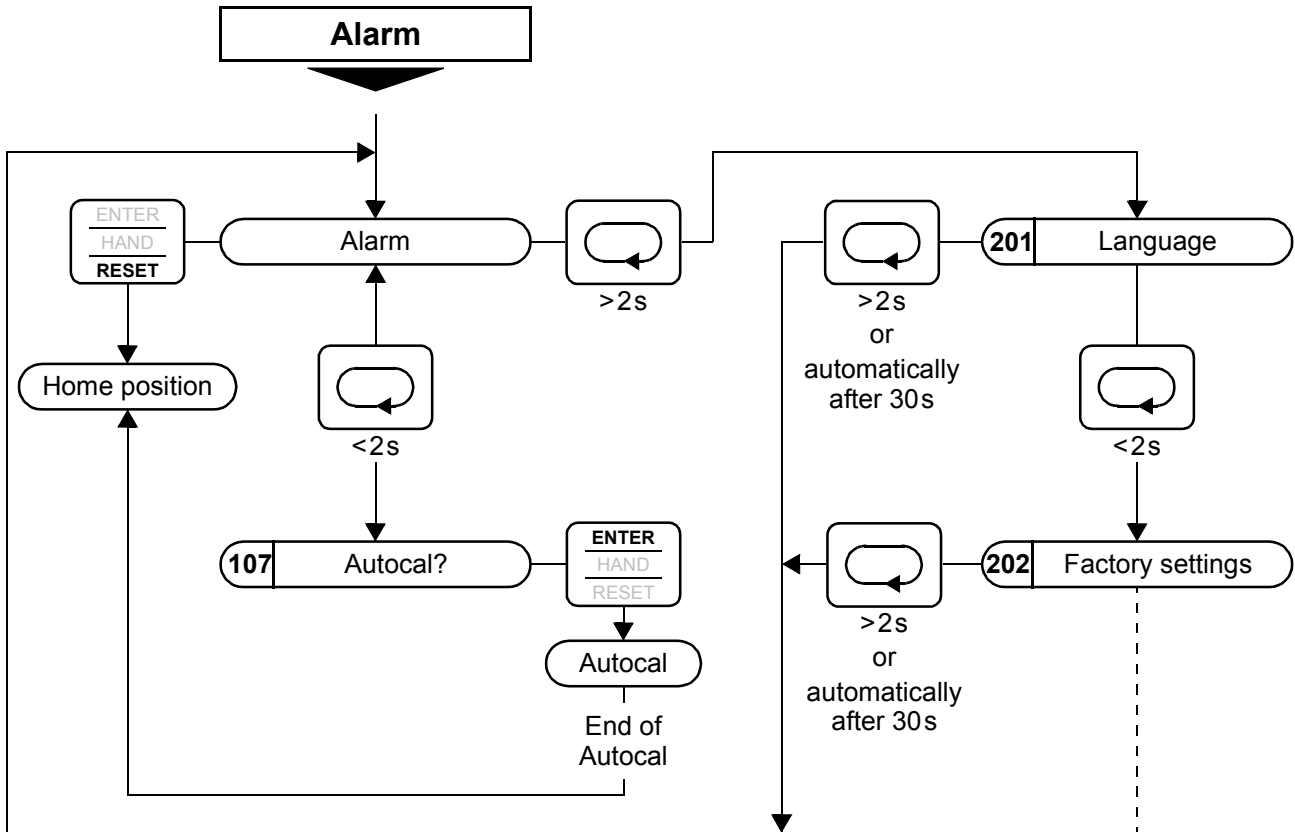

10.4 Menu structure

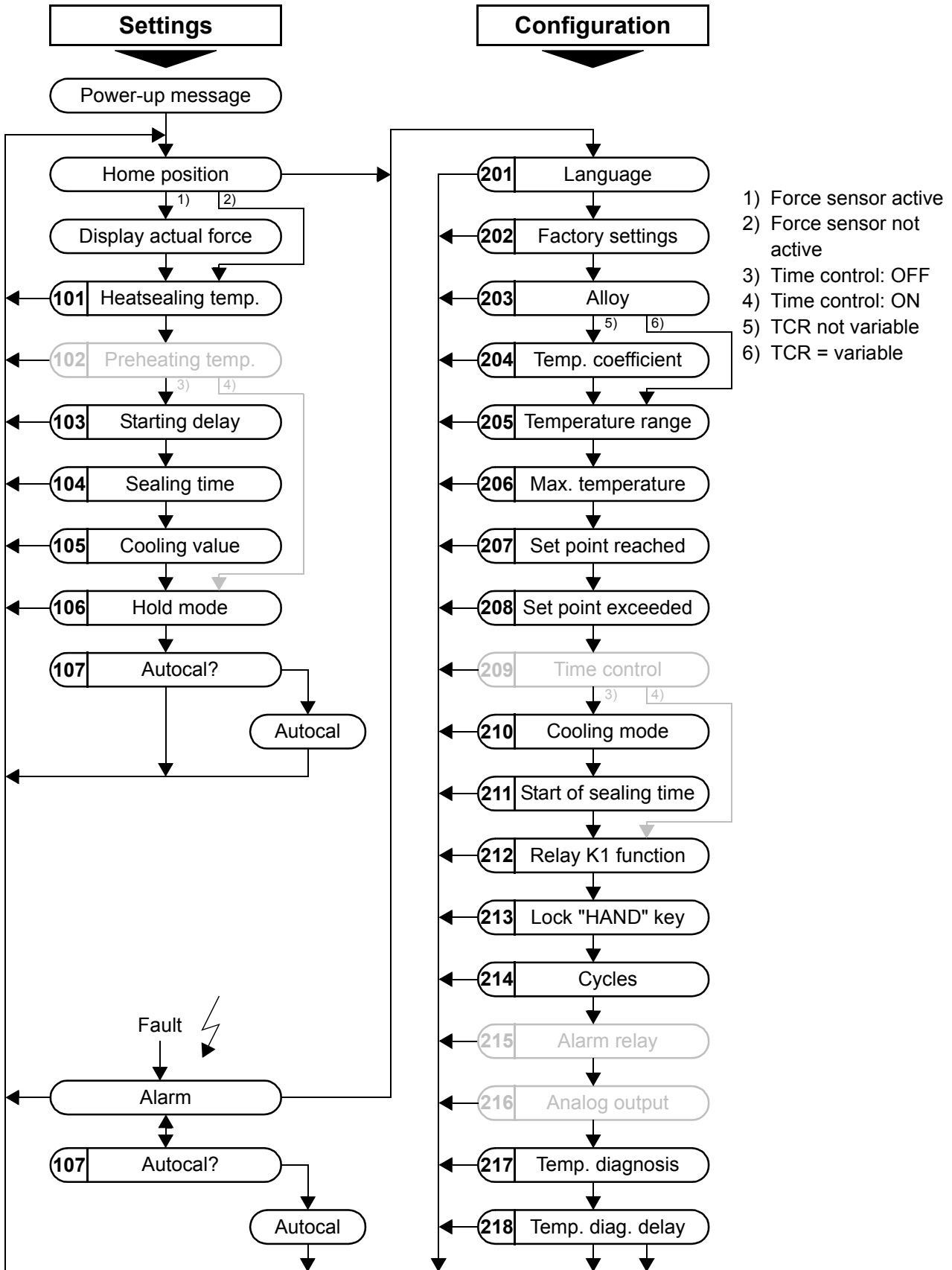

Continued on next page

Configuration

Continued from previous page

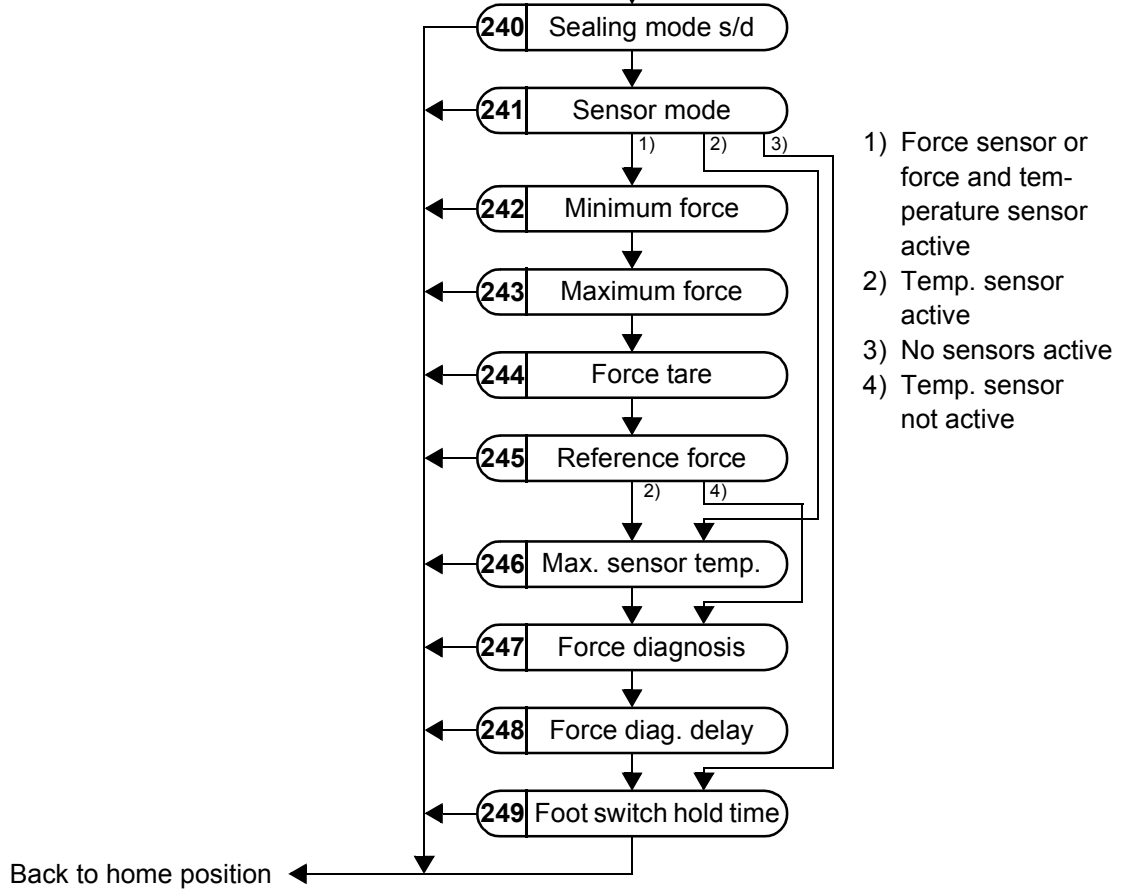

10.5 Two-digit numbering system up to SW revision 006

A system of one and two-digit numbers was used for the Settings and Configuration menus up to SW

revision 006. Three-digit numbers were introduced in SW revision 007 to improve the clarity of the menu structure.

The table below compares the two numbering systems:

Menu	Menu step	Numbering up to SW revision 006	Numbering as of SW revision 007
Settings menu	Heatsealing temperature	1	101
	Starting delay	3	103
	Heatsealing time	4	104
	Cooling value	5	105
	Hold mode	6	106
	AUTOCAL	7	107
Configuration menu	Language	20	201
	Factory settings	21	202
	Alloy / TCR	22	203
	Var. temp. coeff.	23	204
	Temperature range	24	205
	Maximum temperature	25	206
	Cooling mode	28	210
	Start of heatsealing time	29	211
	Relay K1 function	30	212
	Cycle counter	38	214
	Single/double sealing	31	240
	Sensor on/off	32	241
	Load cell minimum force	33	242
	Load cell maximum force	34	243
	Load cell tare	35	244
	Load cell reference force	36	245
Max. sensor temperature	37	246	

 All numbers or menu steps not listed above are only available as of SW revision 007 and are described in section 9 "Startup and operation" on page 16 or section 10.4 "Menu structure" on page 31.

10.6 Temperature setting (set point selection)

The heatsealing temperature can be set by means of menu step 101.

⚠ The maximum value of the setting range is limited either by the maximum value specified with step 206 in the Configuration menu or by the temperature range set with step 205.

The set point that is selected for the heatsealing temperature must be greater than 40°C. If not, the heatsealing band will not be heated up when the "START" signal is activated or the "HAND" key is pressed.

The set heatsealing temperature is displayed in the main menu once it has been entered.

10.7 Temperature indication / actual value output

If the display is in the home position, the ACTUAL temperature is indicated there as a digital value and as a dynamic bar.

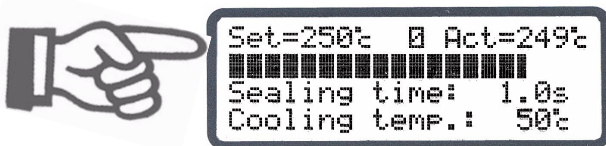

The heating and control process can thus be monitored at any time.

In addition, the RES-430 outputs an analog 0...10VDC signal, which is proportional to the real ACTUAL temperature, at terminals 10+11.

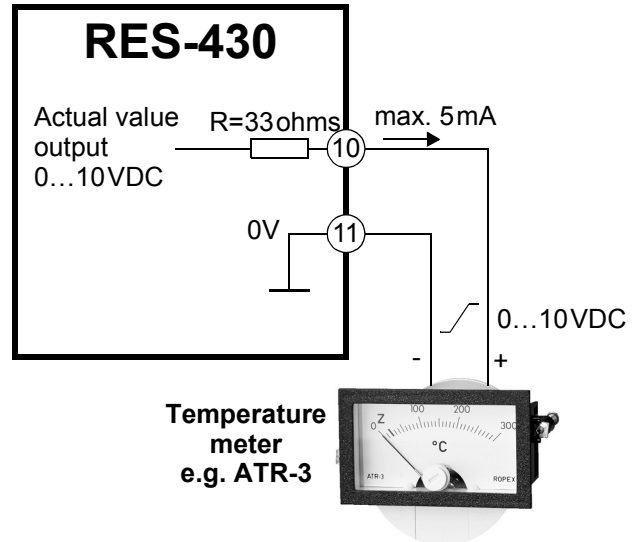

Voltage values:

0VDC → 0°C

10VDC → 300°C or 500°C

(depending on the controller configuration)

The relationship between the change in the output voltage and the ACTUAL temperature is linear.

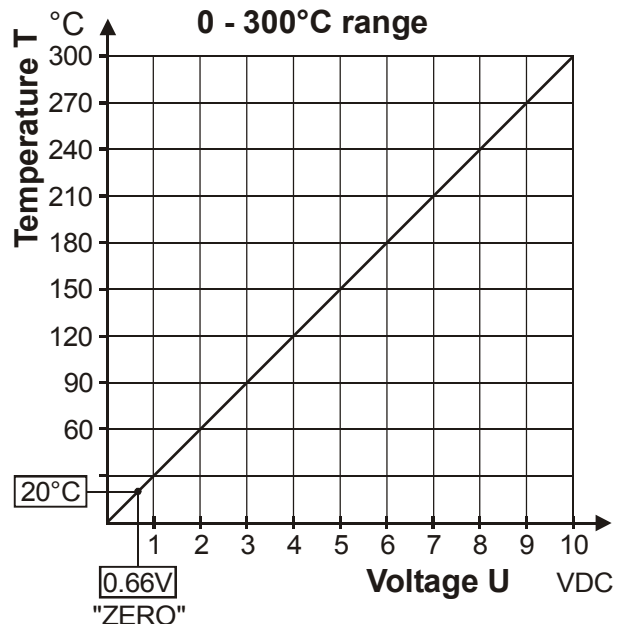

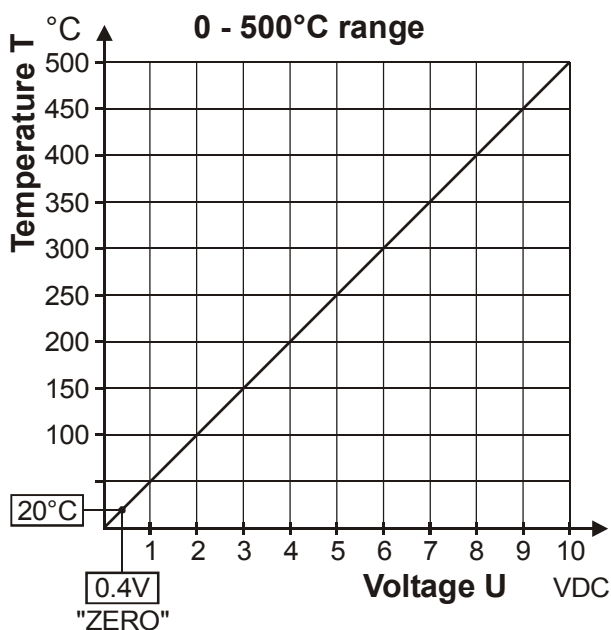

Only the 300°C and 500°C temperature ranges appear at this actual value output. If a temperature range of 200°C is set for the controller with step 205 in the Configuration menu, it appears at this output in the 0...300°C range. A 400°C temperature range is indicated as 0...500°C.

An indicating instrument can be connected to this output in order to visualize the temperature of the heatsealing band.

If an alarm is signaled, this analog output is used – in addition to the value indicated on the controller – to display a selective error message (↪ section 10.19 "Error messages" on page 42).

⚠ This output is not potential-free and could have the potential of the secondary voltage of the impulse transformer. External grounding is not allowed. If this warning is ignored, the controller will be damaged by frame currents. Contact voltage protection must be installed at the terminals of the external temperature meter.

10.8 Automatic zero calibration (AUTOCAL)

Owing to the automatic zero calibration (AUTOCAL) function, there is no need to adjust the zero point manually on the controller. The "AUTOCAL" function matches the controller to the current and voltage signals that are present in the system. You can activate

this function by selecting step 107 in the Settings menu and then pressing the "ENTER" key. The initial temperature (ambient temperature) of the heatsealing bar(s) which is currently valid for calibration can be set beforehand in the 0...40°C range using the "UP" and "DOWN" keys.

The zero point is calibrated in the factory to 20°C.

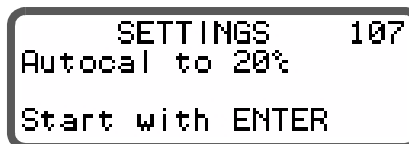

The automatic calibration process takes around 10...15 seconds. The heatsealing band is not heated until the calibration process has finished.

The message "- Calibration - Please wait..." appears on the display while the "AUTOCAL" function is executing and a counter counts down from 14 to 0. The actual value output (terminals 10+11) is set to 0°C (corresponds to 0VDC) for the duration of the calibration process.

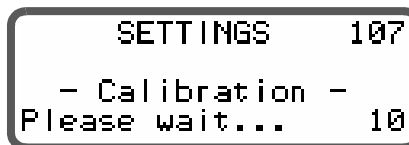

⚠ You should always wait for the heatsealing band and the bar to cool down (to ambient temperature) before activating the "AUTOCAL" function.

Reasons for locked AUTOCAL function:

1. The "AUTOCAL" function cannot be activated if the heatsealing band cools down at a rate of more than 0.1K/second. This is additionally indicated with step 107 in the Settings menu by the message "Heatsealing band still hot! Please wait..."
2. If the "START" signal (HEAT) is activated, the "AUTOCAL" function is not executed. This is additionally indicated with step 107 in the Settings menu by the message "Autocal locked! (START sig. active)".
3. The AUTOCAL function cannot be activated if a fault with error code 101...103, 201...203, 8xx or 9xx occurs (↪ section 10.19 "Error messages" on page 42).

10.9 "FOOT SWITCH" signal

The "FOOT SWITCH" signal is activated by means of a control contact at terminals 12+13.

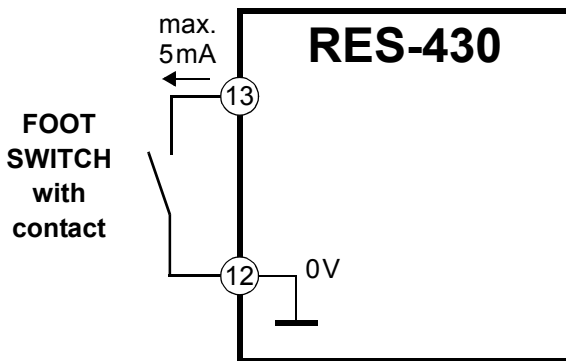

Activating the "FOOT SWITCH" signal energizes relay K1 (or the optional solenoid drive). Among other things, this allows the closing movement of the sealing jaws to be started.

Deactivating the signal deenergizes relay K1 (or the solenoid drive) again immediately, providing relay K1 is not energized by the time control (see section 9.3.7 "Relay K1 / solenoid drive (optional)" on page 21). An additionally parameterizable hold time for the "FOOT SWITCH" signal is described in section 10.10 "Hold time for "FOOT SWITCH" signal" on page 36.

! The "FOOT SWITCH" signal is disabled as long as the AUTOCAL function is executing in the Settings menu (with step 107) or an alarm is displayed.

! It is not possible to activate the "FOOT SWITCH" signal again (in other words, relay K1 or the solenoid drive cannot be energized) for 200ms after it is deactivated in order to prevent bouncing or oscillation of the driven closing movement.

10.10 Hold time for "FOOT SWITCH" signal

A hold time between 0 and 2.0s can be parameterized for the "FOOT SWITCH" signal with step 249 in the Configuration menu. The relay (or the solenoid drive) remains closed for the parameterized time after this signal is activated, even if the signal is deactivated again. Among other things, this permits the closing movement of the sealing jaws to be started by briefly

activating and deactivating the "FOOT SWITCH" signal. The hold time is deactivated if the value entered is "0" (factory setting).

! The time control must energize relay K1 within the parameterized hold time (activation of the "START" signal). If not, the controller indicates an alarm.

10.11 "START" signal (HEAT)

Activating the "START" signal starts the internally parameterized timeout. The time at which the heatsealing band begins to heat up depends on the setting of this parameter. The "START" signal must be deactivated again before the next timeout is activated. Pressing the "HAND" key while the display is in the home position causes the heatsealing band to start heating up immediately. The internal timeout is not started.

The "START" signal is activated by means of a control contact at terminals 12+14.

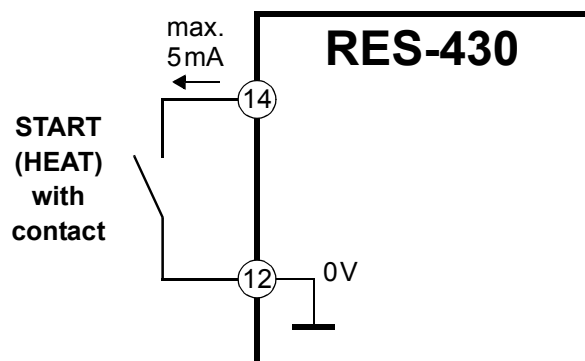

! The "START" signal is disabled as long as the "AUTOCAL" function is executing in the Settings menu (with step 107).

The set point that is selected for the heatsealing temperature (step 101 in the Settings menu) must be greater than 40°C. If not, the heatsealing band will not be heated up.

! As of SW revision 008, it is not possible to activate the "START" signal again (in other words, relay K1 or the solenoid drive cannot be energized) for 200ms after it is deactivated in order to prevent bouncing or oscillation of the driven closing movement.

10.12 Cycle counter

Each activation of the "START" signal during operation is detected by a cycle counter integrated in the controller. Actuations of the "HAND" key are not counted. The counter reading can be displayed with step 214 in the Configuration menu.

The cycle counter is reset to 0 if the "ENTER" key is pressed or if the maximum count of 999.999.999 cycles is exceeded.

10.13 Single/double sealing

Step 240 determines how the two heatsealing bands are heated, depending on the design of the machine or equipment.

If two heatsealing bands for top and bottom heating are installed in the machine, one of these bands can be deactivated for specific applications.

The required settings can be configured with step 240:

1. "Double" (•)

The two heatsealing bands are heated simultaneously. The temperature of both bands is controlled together.

2. "Single"

If two heatsealing bands are connected to the controller, only the first is heated. The second band is not used.

Only the temperature of the first heatsealing band is controlled.

 **If only one heatsealing band is connected to the controller, you must set "Double" with step 240. The controller will otherwise be overloaded and damaged beyond repair.**

(•) Factory setting

 **If you change the configuration with step 240, you must run the AUTOCAL function with step 107. If not, the controller will no longer function correctly.**

10.14 Hold mode

The behavior of the digital indication of the ACTUAL temperature in the home position can be changed with step 206 in the Settings menu.

The following settings are possible:

1. "OFF" (•)

If the main menu is visible on the display, the real ACTUAL temperature is always indicated.

2. "ON"

If the display is in the home position, the ACTUAL temperature that was valid at the end of the last heatsealing phase is always indicated as a digital value. When the controller is switched on - or after an alarm is acknowledged - the real ACTUAL temperature is indicated until the end of the first heating phase.

3. "2 s"

This setting causes the current ACTUAL temperature to be displayed as a digital value for an additional 2 seconds at the end of a heatsealing phase. This temperature is then indicated again in real time until the end of the next heating phase.

 **Hold mode only affects the digital value on the display. The ACTUAL temperature in real time is always indicated, regardless of the setting, by the dynamic bar and the actual value output.**

The various hold modes are shown below:

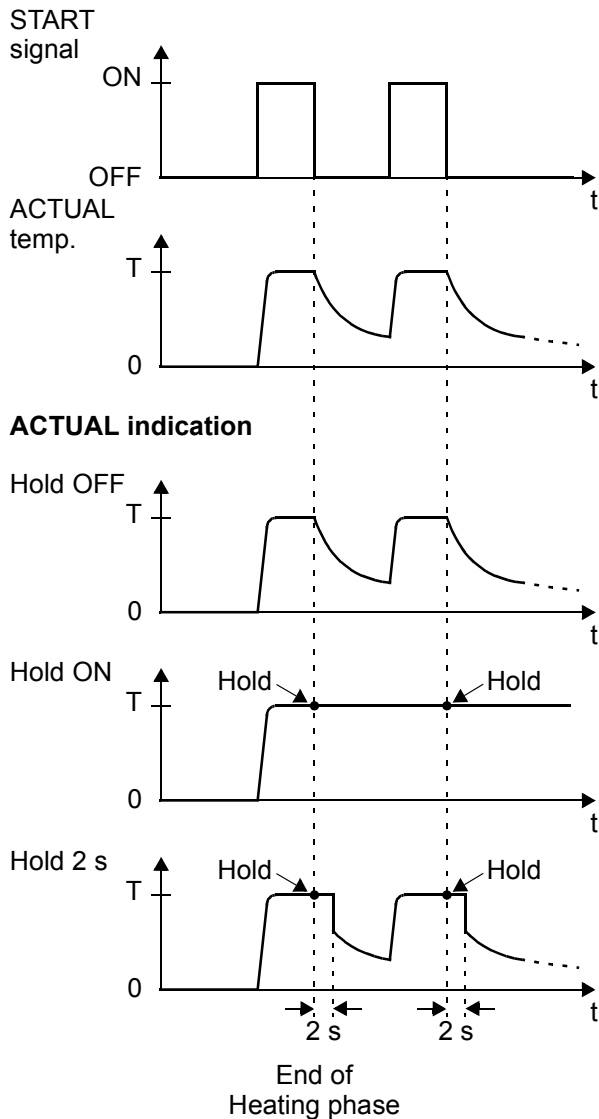

The word "Hold" appears on the display if a temperature value is indicated in hold mode. It disappears for approximately 100ms whenever the hold value is updated.

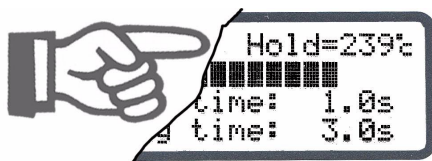

10.15 Locking the "HAND" key

(As of SW revision 007)

The "HAND" key function can be configured with step 213 in the Configuration menu when the display is in the home position.

This prevents the heatsealing bands from being heated if the "HAND" key is pressed inadvertently.

The following settings are possible:

1. Lock "OFF" (•)
Pressing the "HAND" key while the display is in the home position starts a manual heating process. The heatsealing band is heated for as long as the "HAND" key remains pressed.
2. Lock "ON"
The "HAND" key is locked when the display is in the home position, in other words it has no function.

10.16 Locking the Configuration menu

It is possible to disable all changes to values/parameters in the Configuration menu. This prevents the controller configuration from being tampered with by unauthorized persons.

The Configuration menu can be locked or unlocked by pressing the "MENU" key for 2seconds while the power-up message is displayed (after switching on the controller, see section 10.2.1 "Power-up message" on page 27). The display then shows a message confirming that the lock function is active for 2seconds before returning to the home position.



The same message is also displayed for 5seconds when you open the Configuration menu to indicate that this menu is locked.

⚠ You can still display all steps, values and parameters even if the Configuration menu is locked. You are no longer allowed to enter or change values, however.

The Configuration menu remains locked until the lock function is canceled again. To do so, repeat the above procedure (press the "MENU" key for 2seconds while

(•) Factory setting

the power-up message is displayed). The display then shows a message confirming that the lock function has been canceled.

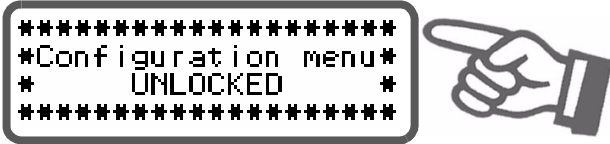

In the factory setting the Configuration menu is not locked.

10.17 Undervoltage detection

(As of SW revision 007)

Trouble-free operation of the temperature controller is guaranteed within the line voltage tolerance range specified in section 6 "Technical data" on page 8.

If a line voltage which is less than the lower limit of the permissible range occurs, the controller is switched to

a standby mode. No more heatsealing processes take place and no more measuring impulses are generated. The display changes to indicate this.

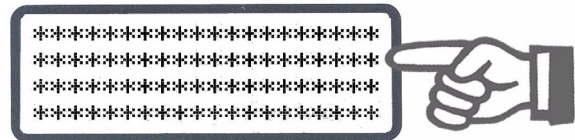

The main menu is displayed again, and operation is resumed, when the input voltage returns to the specified tolerance range.

The standby mode is indicated by 0°C (corresponds to 0V) at the analog output.

⚠ Trouble-free operation of the controller is only guaranteed within the specified input voltage tolerance range. An external voltage monitor must be connected to prevent defective heatseals as a result of low line voltage.

10.17.1 Example

The example below illustrates the basic design of a pneumatically operated L-sealer with a solenoid valve.

The heatsealing process is started by means of a foot switch.

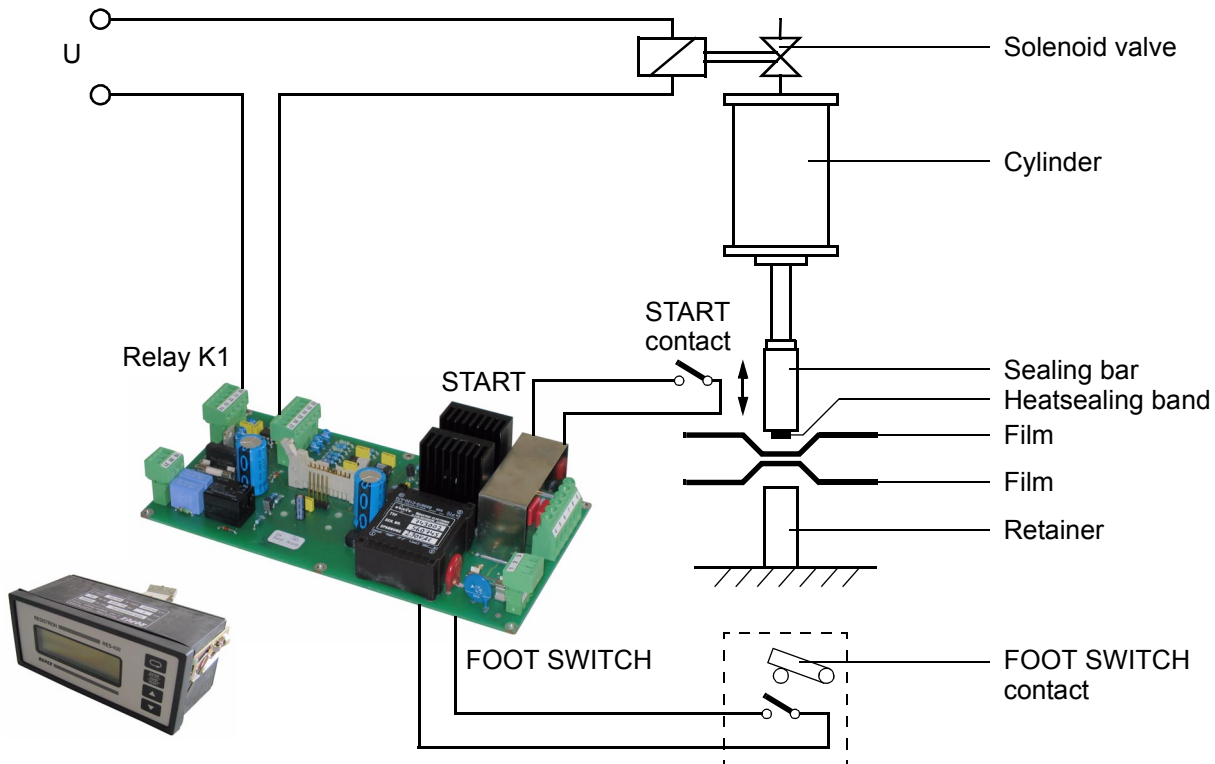

The functional sequence is as follows:

1. The controller receives the signal for energizing relay K1 via the foot switch. The solenoid valve is then energized and the sealing jaws are closed.
2. The switch for the "START" signal is activated when the sealing jaws reach their end position. This starts the timeout for internal time control. Relay K1 must then be energized immediately by the time control (the foot switch can then be opened again but the jaws remain closed).
3. The heating process must begin immediately – without a starting delay.
4. The heatsealing time ($t_2 = 1\text{ s}$) must begin when the ACTUAL temperature reaches 95% of the SET temperature ($T = 180^\circ\text{C}$).
5. The heatsealing bands are not heated any further at the end of the heatsealing phase (i.e. at the end of the heatsealing time). The cooling phase begins.
6. The cooling phase must end when the ACTUAL temperature of the heatsealing bands falls to $T \leq 80^\circ\text{C}$. The sealing jaws are still closed (relay K1 is also still closed).
7. Relay K1 opens again at the end of the cooling phase. The sealing jaws are also opened again.
8. End of the heatsealing process.

The timing sequence can be represented as follows:

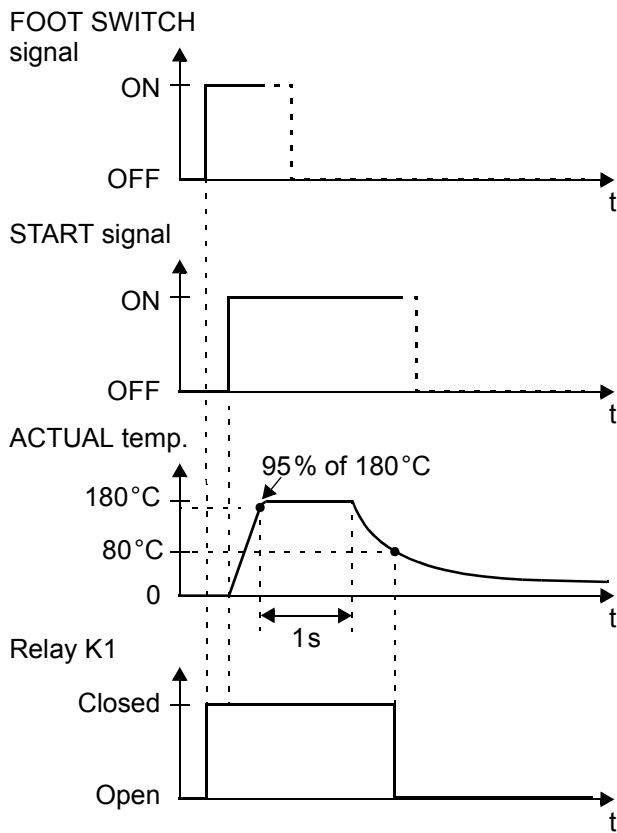

Required controller settings:

The following controller settings are required for time control (the basic settings such as the temperature range, alloy etc. should already have been entered). The settings should be undertaken in the specified order.

Step in Configuration menu	Setting
210 (Cooling mode)	"Absolute"
211 (Start of heatsealing time)	"When temperature reached"
212 (Relay K1 function)	"When start signal present"

Then:

Step in Settings menu	Setting
101 (Heatsealing temperature)	180°C
103 (Starting delay)	0.0 s
104 (Heatsealing time)	1.0 s
105 (Cooling value)	Cooling temperature = 80°C

10.18 System monitoring / alarm output

To increase operating safety and to avoid faulty heatsealing, the controller incorporates special hardware and software features that facilitate selective fault detection and diagnosis. Both the external wiring and the internal system are monitored. These features crucially support the system owner in localizing the cause of an abnormal operating state. A system fault is reported or differentiated by means of the following elements.

A.) Error message on the display:

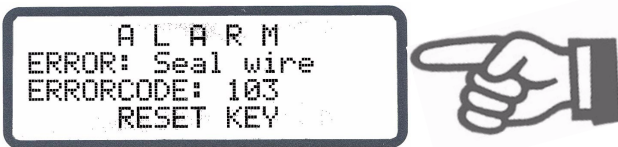

The cause of a fault can be localized quickly and easily with the help of the error code that appears on the display. Please refer to section 10.19 „Error messages“ on page 42 for a list of the possible error codes.

B.) Error code output via the 0 to 10VDC actual value output (terminals 10+11):

Since a temperature indication is no longer necessary if a fault occurs, the actual value output is used to display error codes in the event of an alarm. 13 voltage levels are offered for this purpose in the 0...10VDC range, each of which is assigned an error code (↪ section 10.19 "Error messages" on page 42). If a state that requires AUTOCAL occurs – or if the controller configuration is incorrect – (error codes 104...106, 111...114 or 211), the actual value output jumps back and forth at 1Hz between the voltage value that corresponds to this error and the end of the scale (10VDC, i.e. 300°C or 500°C). If the "START" signal is activated in one of these states, the voltage value does not change any more (as of SW revision 008). Selective fault detection and indication can thus be implemented simply and inexpensively using the analog input of a PLC with a corresponding error message (↪ section 10.19 "Error messages" on page 42).

⚠ An alarm can only be reset by pressing the "RESET" key or by switching the controller off and then on again.



10.19 Error messages

The table below shows how the analog voltage values that appear at the actual value output are assigned to

the faults that have occurred. It also describes each fault and the required corrective action. The block diagram in section 10.20 "Fault areas and causes" on page 45 permits each fault to be cleared quickly and efficiently.

Error code	Act. value output; Voltage [V]	Temp. 300 °C [°C]	Temp. 500 °C [°C]	Cause	Action if machine started for first time	Action if machine already operating, HS band not chang.
101	0.66	20	33	Current signal missing	Fault area ①	Fault area ①
102	1.33	40	66	Voltage signal missing	Fault area ③	Fault area ③
103	2.00	60	100	Voltage and current signals missing	Fault area ②	Fault areas ②③
107	2.66	80	133	Temperature step down	Fault areas ④⑤⑥ (loose contact)	Fault areas ④⑤⑥ (loose contact)
108				Temperature step up		
307	2.66	80	133	Temperature too low		
308				Temperature too high		
201	3.33	100	166	Frequency fluctuation, inadmissible line frequency	Check power supply	Check power supply
202						
203						
801	4.00	120	200	Internal fault	Run RESET	Run RESET
817				Closing force too low		
818				Closing force too high		
820				Force sensor missing		
826				Temperature sensor defective		
828				Sensor temperature too high		
830				Temperature sensor missing		
835	Hold time exceeded					
9xx	4.66	140	233	Internal fault, controller defective	Replace controller	Replace controller

Error code	Act. value output; Voltage [V]	Temp. 300 °C [°C]	Temp. 500 °C [°C]	Cause	Action if machine started for first time	Action if machine already operating, HS band not chang.
104 105 106	↺ 5.33 ↻ ↻ 10 ↻	↺ 160 ↻ ↻ 300 ↻	↺ 266 ↻ ↻ 500 ↻	Voltage and current signals incorrect Impulse transformer incorrectly sized	Run AUTOCAL , check transformer specification, fault areas ⑦⑧	Fault areas ④⑤ ⑥⑦⑧ (loose contact)
302 303			Temperature too low Temperature too high Calibration failed, loose contact, ambient temperature fluctuations	Run AUTOCAL and/or fault areas ④⑤⑥ (loose contact)		
211	↺ 6.00 ↻ ↻ 10 ↻	↺ 180 ↻ ↻ 300 ↻	↺ 300 ↻ ↻ 500 ↻	Data error	Run AUTOCAL	---
111	↺ 6.66 ↻ ↻ 10 ↻	↺ 200 ↻ ↻ 300 ↻	↺ 333 ↻ ↻ 500 ↻	Current signal incorrect, calibration not possible	Fault area ⑧, check configuration	---
112	↺ 7.33 ↻ ↻ 10 ↻	↺ 220 ↻ ↻ 300 ↻	↺ 366 ↻ ↻ 500 ↻	Voltage signal incorrect, calibration not possible	Fault area ⑦, check configuration	---
113	↺ 8.00 ↻ ↻ 10 ↻	↺ 240 ↻ ↻ 300 ↻	↺ 400 ↻ ↻ 500 ↻	Current and voltage signals incorrect, calibration not	Fault areas ⑦⑧, check configuration	---
114	↺ 8.66 ↻ ↻ 10 ↻	↺ 260 ↻ ↻ 300 ↻	↺ 433 ↻ ↻ 500 ↻	Temperature fluctuations, calibration not possible		

10.20 Fault areas and causes

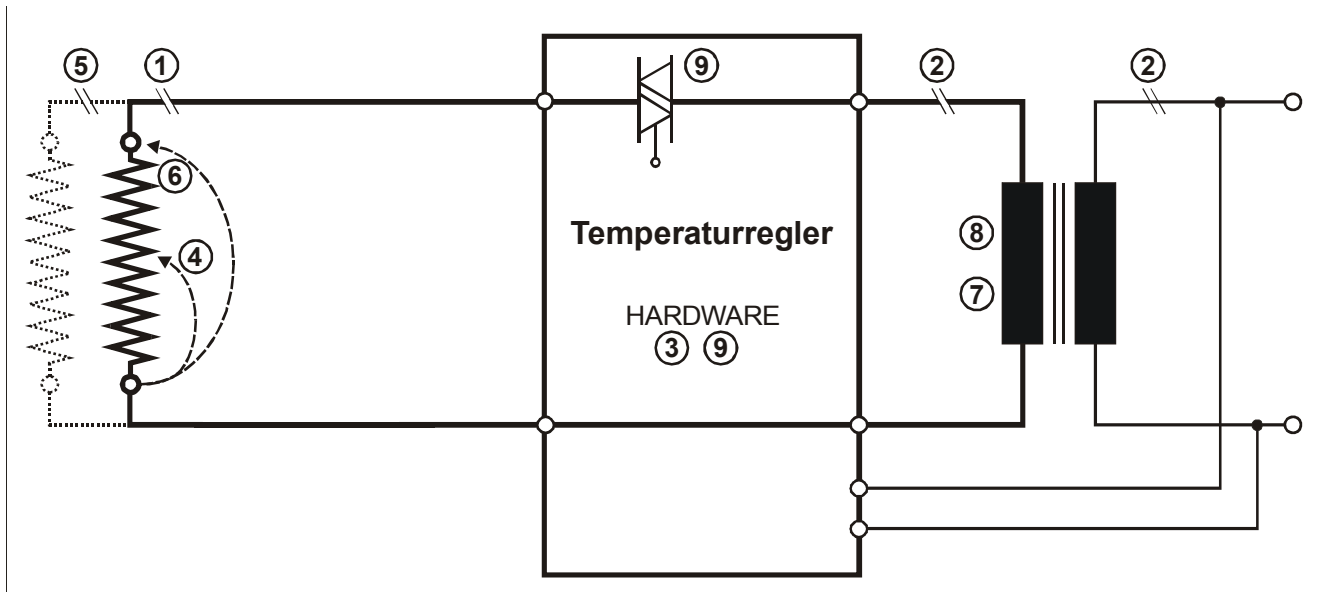

The table below explains the possible fault causes.

Fault area	Explanation	Possible causes
①	Load circuit interrupted	- Wire break, heatsealing band break - Contacting to heatsealing band defective
②	Primary circuit interrupted	- Wire break, triac in controller defective - Primary winding of impulse transformer interrupted
	Secondary circuit interrupted	- Wire break - Secondary winding of impulse transformer interrupted
③	Voltage measurement signal missing, internal controller fault	- Hardware fault (replace controller)
④	Partial short-circuit (delta R)	- Heatsealing band partially bypassed by conducting part (clamp, opposite heatsealing bar etc.)
⑤	Parallel circuit interrupted	- Wire break, heatsealing band break - Contacting to heatsealing band defective
⑥	Total short-circuit	- Heatsealing band installed incorrectly, insulation at heatsealing bar ends missing or incorrectly installed - Conducting part bypasses heatsealing band completely
⑦	Controller voltage measurement signal outside permissible range	- Check impulse transformer specification, heed information in ROPEX Application Report
⑧	Controller current measurement signal outside permissible range	- Check impulse transformer specification, heed information in ROPEX Application Report
⑨	Internal controller fault	- Hardware fault (replace controller)

11 Factory settings

11.1 Ropex settings

The RES-430 RESISTRON temperature controller is configured in the factory as follows (Ropex settings):

<u>Values in the Settings and Configuration menus</u>	Settings menu	
	Step 101 Heatsealing temperature:	0°C
	Step 103 Starting delay:	0s
	Step 104 Heatsealing time:	1s
	Step 105 Cooling value:	Cooling time: 10 s Absolute cooling temp.: 50°C Relative cooling temp.: 40 % of heatsealing temperature
	Step 106 Hold mode:	OFF
	Step 107 AUTOCAL temperature:	20°C
	Configuration menu	
	Step 201 Language	German This selection is NOT changed if the factory settings are restored with step 202 in the Configuration menu
	Step 203 Alloy/TCR:	1100ppm, Alloy-20
	Step 204 Variable temp. coeff.:	1100ppm
	Step 205 Temperature range:	300°C
	Step 206 Maximum temperature:	300°C
	Step 207 Set point reached:	-10K
	Step 208 Set point exceeded:	+10K
	Step 210 Cooling mode:	Absolute
	Step 211 Start of heatsealing time:	When temperature reached
	Step 212 Relay K1 function:	Active when "START" signal present
	Step 213 Lock "HAND" key	OFF
	Step 214 Cycle counter:	0
	Step 217 Temperature diagnosis:	OFF
	Step 218 Temp. diagnosis delay:	0s
	Step 240 Single/double sealing:	Double
	Step 241 Sensor mode:	OFF
	Step 242 Load cell minimum force:	0N
	Step 243 Load cell maximum force:	1500N
	Step 244 Load cell tare:	0N
	Step 245 Load cell reference force:	680N
	Step 246 Max. sensor temperature:	50°C
	Step 247 Force diagnosis:	OFF
	Step 248 Force diagnosis delay	0s
	Step 249 Foot switch hold time:	0s

11.2 Customer settings

The controller factory settings can be specified or restored with step 202 in the Configuration menu. You can also store customer settings in addition to the Ropex settings:

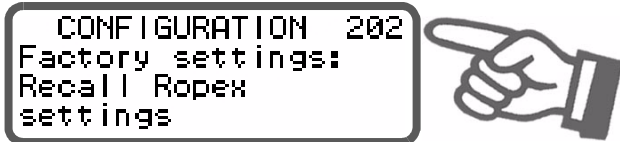

The following settings are possible:

1. **"Restore Ropex settings" (•)**
Selecting this option restores the menu values listed in section 11.1 "Ropex settings" on page 46. These values correspond to the factory settings with which the controller was delivered.
2. **"Define customer settings"**
Selecting this option saves the values that are currently set in the controller Settings and Configuration menus as "customer settings". These "customer settings" are independent of the Ropex settings. Machine-specific settings can be stored in the controller in this way.
3. **"Restore customer settings"**
Selecting this option restores the "customer settings" that were saved as described in 2.

(•) Factory setting

When the controller is first delivered, the "customer settings" are identical to the Ropex settings.

After pressing the "ENTER" key in this menu step, you are asked to confirm the new settings (safety query).

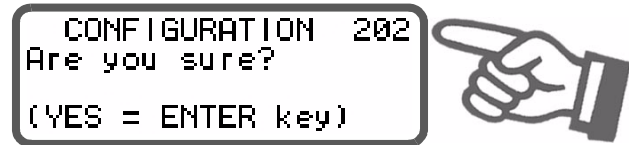

Another message appears if you now confirm these settings by pressing the "ENTER" key for approximately 2seconds.

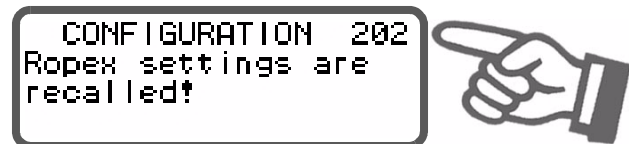

You can also cancel the new settings by pressing the "MENU", cursor "UP" or cursor "DOWN" keys. Step 203 then appears on the display.





The language which is selected with step 201 in the Configuration menu remains set even if the previous settings are restored.

12 Maintenance

The controller requires no special maintenance. Regular inspection and/or tightening of the terminals – including the terminals for the winding connections on

the impulse transformer – is recommended. Dust deposits on the controller can be removed with dry compressed air.

13 How to order

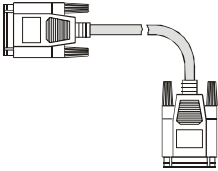
	<p>Controller RES -430 / . . . VAC Standard controller with relay K1</p> <p>  115: Line voltage 115VAC, Art. No. 743001 230: Line voltage 230VAC, Art. No. 743002 </p> <p>Scope of supply: Motherboard (includes connector plug-in parts) and T-430 terminal</p>
	<p>Line filter LF- 06480</p> <p>Continuous current 6A, 480VAC, Art. No. 885500</p>
	<p>Impulse transformer</p> <p>See ROPEX Application Report for design and ordering information</p>
	<p>Optional data interface (piggyback module)</p> <p>Art. No. 743099</p>
	<p>Sub-D connecting cable for optional data interface (for connection to piggyback module)</p> <p> Length 2m: Art. No. 884202 Length 5m: Art. No. 884205 Length 10m: Art. No. 884210 </p>

14 Index

A

Actual value output 34
 Alarm output 42
 Alloy 17, 26
 Ambient temperature 9
 Analog output 8
 Application 4
 Application Report 12
 AUTOCAL 5, 26, 35
 Automatic zero calibration 5, 26, 35
 AUTOTUNE 5

B

Burning in heatsealing band 25, 26

C

Calibration, load cell 24
 Circuit breaker 13
 Connecting cable 48
 Controller configuration 17
 Controls 27
 Cooling mode 19
 Customer settings 47

D

Data interface 6
 Degree of protection 9
 Delay time, force diagnosis 23
 Delay time, temperature diagnosis 22
 Dimensions 10
 Display 27

F

Factory settings 17, 46
 Fault areas 45
 Fault diagnosis 5
 "FOOT SWITCH" signal 8, 36
 Force diagnosis 23

H

HEAT 26, 36
 Heatsealing band type 8
 Hold mode 37
 Hold time for "FOOT SWITCH" signal 36

I

Impulse heatsealing method 4
 Impulse transformer 13, 48
 Installation 9, 12
 Installation procedure 12
 Installation regulations 12

L

Line filter 13, 48
 Line frequency 5, 8
 Line voltage 8
 Load cell interface 8, 23
 Load current 8
 Locking Configuration menu 38
 Locking "HAND" key 38

M

Maintenance 47
 Manual mode 34
 Modifications 6

O

Overheating of heatsealing band 5

P

Piggyback module 6
 Power supply 13
 Principle of operation 5

R

Relay K1 8, 21
 Replacing heatsealing band 25, 26
 Ropex settings 46

S

Set point selection 8, 34
 Single/double sealing 37
 Software 7
 Solenoid drive 8, 21
 Standby mode 39
 "START" signal 26, 36
 System monitoring 42

T

TCR 3, 25
 Temperature coefficient 3, 17, 25
 Temperature control 4
 Temperature diagnosis 22
 Temperature indication 34
 Temperature range 8, 18
 Temperature sensor 9, 23
 Temperature setting 34
 Transformer 3, 13, 48
 Type of construction 8

U

Undervoltage detection 39

V

View 16
Visualization software 7

W

Wiring 12, 13
Wiring diagram with relay K1 14
Wiring diagram with solenoid drive 15