

## RES-409

®

### Operating instructions



#### Important features

- Microprocessor technology
- Complete control via CAN-Bus interface
- Automatic zero calibration (AUTOCAL)
- Automatic optimization (AUTOTUNE)
- Automatic frequency adjustment
- Large current and voltage range
- 0...10VDC analog output for ACTUAL temperature
- Alarm function with fault diagnosis
- Heatsealing band alloy and temperature range selectable

## Contents

<b>1</b>	<b>Safety and warning notes</b>	<b>3</b>	<b>9</b>	<b>Startup and operation</b>	<b>15</b>
1.1	Use	3	9.1	View of the controller	15
1.2	Heatsealing band	3	9.2	Controller configuration	15
1.3	Impulse transformer	3	9.3	Heatsealing band	18
1.4	Current transformer PEX-W2	3	9.4	Startup procedure	19
1.5	Line filter	4	<b>10</b>	<b>Controller functions</b>	<b>20</b>
1.6	Warranty provisions	4	10.1	Indicators and controls	20
1.7	Standards / CE marking	4	10.2	CAN protocol	20
<b>2</b>	<b>Application</b>	<b>4</b>	10.3	Receiving CAN messages	21
<b>3</b>	<b>Principle of operation</b>	<b>5</b>	10.4	Sending CAN messages	24
<b>4</b>	<b>Description of the controller</b>	<b>6</b>	10.5	Temperature indication (actual value output)	25
<b>5</b>	<b>Accessories and modifications</b>	<b>6</b>	10.6	System monitoring/alarm output	27
5.1	Accessories	6	10.7	Error messages	27
5.2	Modifications (MODs)	7	10.8	Fault areas and causes	29
<b>6</b>	<b>Technical data</b>	<b>8</b>	<b>11</b>	<b>Factory settings</b>	<b>30</b>
<b>7</b>	<b>Dimensions</b>	<b>9</b>	<b>12</b>	<b>Maintenance</b>	<b>30</b>
<b>8</b>	<b>Installation</b>	<b>9</b>	<b>13</b>	<b>How to order</b>	<b>31</b>
8.1	Installation procedure	9	<b>14</b>	<b>Index</b>	<b>32</b>
8.2	Installation steps	10			
8.3	Power supply	11			
8.4	Line filter	12			
8.5	Current transformer PEX-W2	12			
8.6	Wiring diagram (standard)	13			
8.7	Wiring diagram with booster connection (MOD 26)	14			

# 1 Safety and warning notes

This RESISTRON temperature controller is manufactured according to DIN EN 61010-1. In the course of its manufacture it passed through quality assurance, whereby it was subjected to extensive inspections and tests.

It left the factory in perfect condition.

The recommendations and warning notes contained in these operating instructions must be complied with, in order to guarantee safe operation.

The device can be operated within the limits indicated in the "Technical Data" without impairing its operational safety. Installation and maintenance may only be performed by technically trained, skilled persons who are familiar with the associated risks and warranty provisions.

## 1.1 Use

RESISTRON temperature controllers may only be used for heating and temperature control of heatsealing bands which are expressly suitable for them, and providing the regulations, notes and warnings contained in these instructions are complied with.

 **In case of non-compliance or use contrary to the intended purpose, there is a risk that safety will be impaired or that the heatsealing band, electrical wiring, transformer etc. will overheat. Ensuring such compliance is the personal responsibility of the user.**

## 1.2 Heatsealing band

A basic prerequisite for reliable and safe operation of the system is the use of suitable heatsealing bands.

 **The resistance of the heatsealing band which is used must have a positive minimum temperature coefficient in order to guarantee trouble-free operation of the RESISTRON temperature controller.**

The temperature coefficient must be specified as follows:

$$TCR \geq 10 \times 10^{-4} \text{ K}^{-1}$$

e.g. Alloy-20: TCR = 1100 ppm/K  
NOREX: TCR = 3500 ppm/K

The RESISTRON temperature controller must be set and coded according to the temperature coefficient of the heatsealing band.

 **The use of incorrect alloys with too low a temperature coefficient and incorrect coding of the RESISTRON temperature controller leads to uncontrolled heating and ultimately to burn-out of the heatsealing band!**

The heatsealing bands that were originally supplied must be identified by their detailed specification, part number or some other means to ensure that all replacement bands are identical.

## 1.3 Impulse transformer

A suitable impulse transformer is necessary to ensure that the control loop functions perfectly. This transformer must be designed according to VDE 0570/EN 61558 (isolating transformer with reinforced insulation) and have a one-section bobbin. When the impulse transformer is installed, suitable shock protection must be provided in accordance with the national installation regulations for electrical equipment. In addition, water, cleaning solutions and conductive fluids must be prevented from seeping into the transformer.

 **Incorrect installation of the impulse transformer impairs electrical safety.**

## 1.4 Current transformer PEX-W2

The current transformer supplied with the RESISTRON temperature controller is an integral part of the control system.

 **Only the original ROPEX PEX-W2 current transformer may be used. Other transformers may cause the equipment to malfunction.**

The current transformer may only be operated if it is connected to the RESISTRON temperature controller correctly (see section 9, "Startup and operation"). The relevant safety instructions contained in section 8.3, "Power supply", must be obeyed. External monitoring modules can be used in order to additionally increase operating safety. They are not included in the scope of

supply of the standard control system and are described in a separate document.

### 1.5 Line filter

The use of an original ROPEX line filter is mandatory in order to comply with the standards and provisions mentioned in section 1.7 "Standards / CE marking" on page 4. This device must be installed and connected according to the instructions contained in section 8.3, "Power supply" as well as the separate documentation enclosed with the line filter.

### 1.6 Warranty provisions

The statutory provisions for warranties apply for a period of 12 months following the delivery date.

All devices are tested and calibrated in the factory. Devices that have been damaged due to faulty connections, dropping, electrical overloading, natural wear, incorrect or negligent handling, chemical influences or mechanical overloading as well as devices that have been modified, relabeled or otherwise altered by the customer, for example in an attempt to repair them or install additional components, are excluded from the warranty.

Warranty claims must be examined in the factory and approved by ROPEX.

### 1.7 Standards / CE marking

The controller described here complies with the following standards, provisions and directives:

DIN EN 61010-1 (VDE 0411-1)	Safety provisions for electrical measuring, control and laboratory devices (low voltage directive). Overvoltage category III, pollution severity 2, safety class II.
DIN EN 60204-1	Electrical equipment of machines (machinery directive)
EN 50081-1	EMC interference emissions according to EN 55011, group 1, class B
EN 50082-2	EMC interference immunity: ESDs, RF radiation, bursts, surges.

Compliance with these standards and provisions is only guaranteed if original accessories and/or peripheral components approved by ROPEX are used. If not, then the equipment is operated on the user's own responsibility.

The CE marking on the controller confirms that the device itself complies with the above-mentioned standards.

It does not imply, however, that the overall system also fulfils these standards.

It is the responsibility of the machine manufacturer and of the user to verify the completely installed, wired and operationally ready system in the machine with regard to its conformity with the safety provisions and the EMC directive (see also section 8.3, "Power supply"). If peripheral components (e.g. the transformer or the line filter) from other manufacturers are used, no functional guarantee can be provided by ROPEX.

## 2 Application

This RESISTRON temperature controller is an integral part of the "series 400", the outstanding feature of which is its microprocessor technology. All RESISTRON temperature controllers are used to control the temperature of heating elements (heatsealing bands, beaded bands, cutting wires, heatsealing blades, solder elements etc.), as required in a variety of heatsealing processes.

The controller is most commonly used for impulse-heatsealing PE films in:

- Vertical and horizontal f/f/s machines
- Pouch, filling and sealing machines
- Film wrapping machines
- Pouch-making machines
- Group packaging machines
- etc.

The use of RESISTRON temperature controllers results in:

- Repeatability quality of the heatseals under any conditions

- Increased machine capacity
- Extended life of the heatsealing bands and teflon coatings
- Simple operation and control of the sealing process

### 3 Principle of operation

The resistance of the heatsealing band, which is temperature-sensitive, is monitored 50x per second (60x at 60Hz) by measuring the current and voltage. The temperature calculated with the help of these measurements is displayed and compared with the set point.

The primary voltage of the impulse transformer is adjusted by phase-angle control if the measured values deviate from the set point. The resulting change in the current through the heatsealing band leads to a change in the band temperature and thus also its resistance. This change is measured and evaluated by the RESISTRON temperature controller.

The control loop is closed: ACTUAL temperature = SET temperature. Even minute thermal loads on the heatsealing band are detected and can be corrected quickly and precisely.

The thermoelectric control loop which is formed has a highly dynamic response because purely electrical variables are measured at a high sampling rate. A high secondary current can be controlled because power is controlled on the primary side of the transformer. This

allows optimum adaptation to the load and to the required dynamic range despite the exceptionally compact dimensions of the controller.

#### PLEASE NOTE!

RESISTRON temperature controllers play a significant role in enhancing the performance of modern machines. However, the full benefit can only be obtained from the advanced technology offered by this control system if all the system components, in other words the heatsealing band, the impulse transformer, the wiring, the timing signals and the controller itself, are compatible with one another and interrelated.

**We will be pleased to contribute our many years of experience towards optimizing your heatsealing system.**

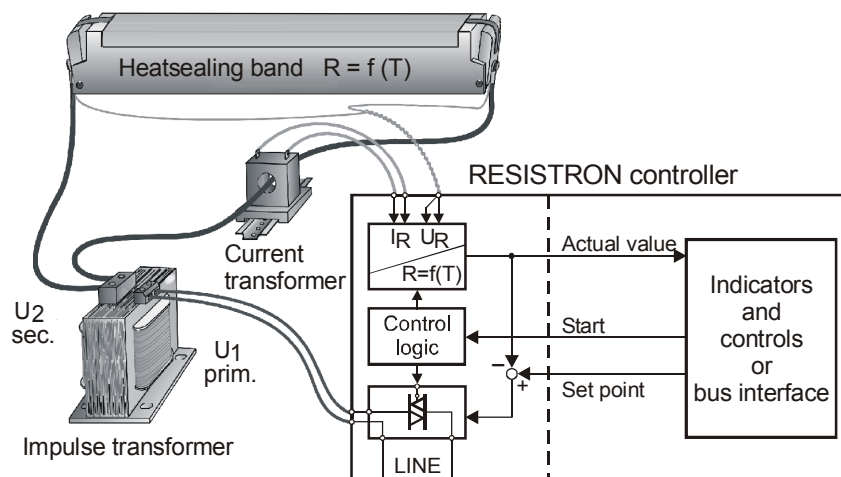

## 4 Description of the controller

The microprocessor technology endows the RESISTRON temperature controller RES-409 with previously unattainable capabilities:

- Very simple operation thanks to AUTOCAL, the automatic zero calibration function.
- Good dynamic response of the control system thanks to AUTOTUNE, which adapts automatically to the controlled system.
- High precision thanks to further improved control accuracy and linearization of the heatsealing band characteristic.
- High flexibility: the secondary voltage range from 1V to 120V is covered with only 3 DIP switches, with 2 DIP switches for the current range from 30A to 400A.
- Automatic adjustment to the line frequency in the range from 47Hz to 63Hz.
- Increased protection against dangerous conditions, such as overheating of the heatsealing band.

The RESISTRON temperature controller RES-409 is equipped with a CAN-Bus interface. This interface can

be used to control all the controller functions and interrogate controller information.

The ACTUAL temperature of the heatsealing band is supplied to the CAN-Bus interface and to an analog 0 to 10V DC output. The real heatsealing band temperature can thus be displayed on an external temperature meter (e.g. ATR-x).

The RES-409 features an integrated fault diagnosis function, which tests both the external system (heatsealing band, wiring etc.) and the internal electronics and outputs a selective error message in case of a fault.

To increase operational safety and interference immunity, all CAN-Bus signals are electrically isolated from the controller and the heating circuit.

Either coding switches on the temperature controller itself or the CAN-Bus interface can be used to adapt to different heatsealing band alloys (Alloy-20, NOREX etc.) and set the required temperature range (0...300°C, 0...500°C etc.).



The compact design of the RESISTRON temperature controller RES-409 and the plug-in connections make this controller easy to install.



## 5 Accessories and modifications

A wide range of compatible accessories and peripheral devices are available for the RESISTRON temperature controller RES-409. They allow it to be optimally adapted to your specific heatsealing application and to your plant's design and operating philosophy.

### 5.1 Accessories

The products described below are only a few of the wide range of accessories available for RESISTRON temperature controllers (↪ "Accessories" leaflet).

	<p><b>Analog temperature meter ATR-x</b> For front panel mounting or mounting on a top hat rail (DIN TS35 rail). Analog indication of the ACTUAL temperature of the heatsealing band in °C. The meter damping of the unit is optimized for the abrupt temperature changes that occur in impulse mode.</p>
	<p><b>Digital temperature meter DTR-x</b> For front panel mounting or mounting on a top hat rail (DIN TS35 rail). Digital indication of the ACTUAL temperature of the heatsealing band in °C, with HOLD function.</p>
	<p><b>Line filter LF-xx480</b> Essential in order to ensure CE conformity. Optimized for the RESISTRON temperature controller.</p>

	<p><b>Impulse transformer ITR-x</b>                  Designed according to VDE 0570/EN 61558 with a one-section bobbin.                  Optimized for impulse operation with RESISTRON temperature controllers.                  Specified according to the heatsealing application                  (↪ ROPEX Application Report).</p>
	<p><b>Booster B-xxx400</b>                  External switching amplifier, necessary for high primary currents (continuous current &gt; 5A, pulsed current &gt; 25A).</p>
	<p><b>Monitoring current transformer MSW-1</b>                  For detecting frame short-circuits on the heatsealing band.                  Used as an alternative to the standard PEX-W2 current transformer.</p>

## 5.2 Modifications (MODs)

Owing to its universal design, the RESISTRON temperature controller RES-409 is suitable for a very wide range of heatsealing applications.

Two modifications (MOD) are available for the RESISTRON temperature controller RES-409 for implementing special applications.

### MOD 01

Amplifier for low secondary voltages ( $U_R = 0.25 \dots 16VAC$ ). This modification is necessary, for example, for very short or low-resistance heatsealing bands.

### MOD 26

Additional terminal for connecting an external switching amplifier (booster). This modification is necessary for high primary currents (continuous current > 5A, pulsed current > 25A).

## 6 Technical data

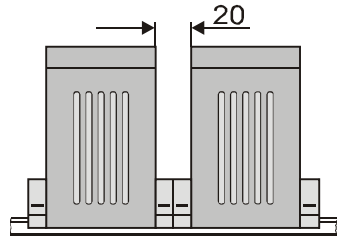
<b>Type of construction</b>	Housing for installation in the electrical cabinet Snaps onto a standard top hat rail (DIN TS35 rail, 35mm) acc. to DIN EN 50022 Dimensions: 90 x 75mm; height: 135mm (incl. terminals)
<b>Line voltage</b>	<p><u>All controllers manufactured as of January 2004:</u> 115VAC version: 115VAC -15%...120VAC +10% (equivalent to 98...132VAC) 230VAC version: 230VAC -15%...240VAC +10% (equivalent to 196...264VAC) 400VAC version: 400VAC -15%...415VAC +10% (equivalent to 340...456VAC)</p> <p><u>All controllers manufactured up to December 2003:</u> 115VAC, 230VAC or 400VAC, tolerance: +10% / -15%</p> <p>depending on device version (↪ section 13 "How to order" on page 31)</p>
<b>Line frequency</b>	47...63Hz, automatic adjustment to frequencies in this range
<b>CAN interface</b>	Baud rates: 10kBaud; 50kBaud; 125kBaud; 205kBaud; 250kBaud; 500kBaud; 800kBaud; 1MBaud 2 x 3-pole M8 circular connector acc. to IEC 947-5-2
<b>Heatsealing band type and temperature range</b>	Six ranges selectable via the CAN interface: Temperature coefficient 1100ppm, 0...200°C (e.g. Alloy A20) Temperature coefficient 1100ppm, 0...300°C (e.g. Alloy A20) Temperature coefficient 1100ppm, 0...400°C (e.g. Alloy A20) Temperature coefficient 1100ppm, 0...500°C (e.g. Alloy A20) Temperature coefficient 3500ppm, 0...200°C (e.g. NOREX) Temperature coefficient 3500ppm, 0...300°C (e.g. NOREX)
<b>Analog output</b> (actual value) Terminals 17+18	0...10V DC, $I_{max} = 5\text{mA}$ Equivalent to 0...300°C or 0...500°C
<b>Alarm relay</b> Terminals 12, 13, 14	$U_{max} = 50\text{VDC}$ , $I_{max} = 0.2\text{A}$ , changeover contact, potential-free
<b>Maximum load</b> (primary current of impulse transformer)	$I_{max} = 5\text{A}$ (duty cycle = 100%) $I_{max} = 25\text{A}$ (duty cycle = 20%)
<b>Ambient temperature</b>	+5...+45°C
<b>Degree of protection</b>	IP20
<b>Installation</b>	<p>If several controllers are installed on one top hat rail (DIN TS35 rail), a clearance of at least 20mm should be allowed between them.</p> 
<b>Weight</b>	Approx. 0.7kg (incl. connector plug-in parts)



<b>Housing material</b>	Plastic, UL-94-1, self-extinguishing
<b>Connecting cables</b> Type / cross-sections	Rigid or flexible; 0.2...2.5 mm <sup>2</sup> (AWG 24...12) Plug-in connectors

## 7 Dimensions

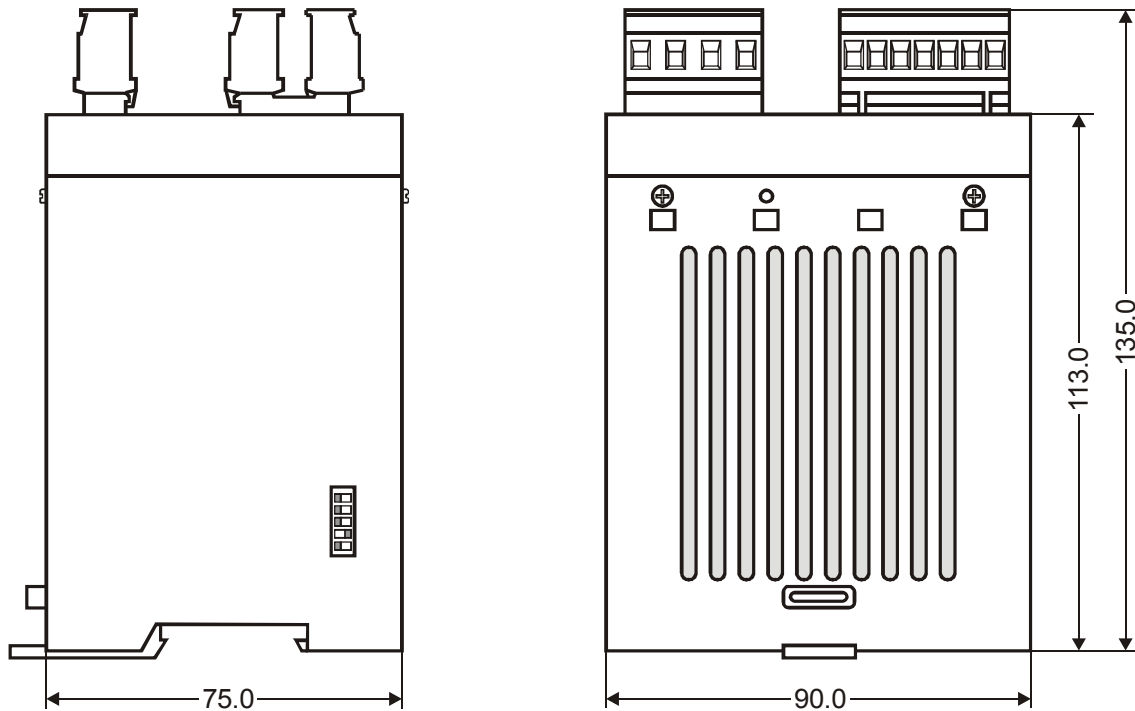

## 8 Installation

↪ See also section 1 "Safety and warning notes" on page 3.

**⚠ Installation and startup may only be performed by technically trained, skilled persons who are familiar with the associated risks and warranty provisions.**

### 8.1 Installation procedure

Proceed as follows to install the RESISTRON temperature controller RES-409:

1. Switch off the line voltage and verify that all circuits are deenergized.
2. The supply voltage specified on the nameplate of the RESISTRON temperature controller must be identical to the line voltage that is present in the plant or machine. The line frequency is automatically detected by the temperature controller in the range from 47Hz to 63Hz.
3. Install the RESISTRON temperature controller in the electrical cabinet on a standard top hat rail (DIN TS35 rail, according to DIN EN 50022). If several controllers are installed on one top hat rail, the minimum clearance specified in section 6 "Technical data" on page 8 must be allowed between them.

4. Wire the system in accordance with the instructions in section 8.3 "Power supply" on page 11, section 8.6 "Wiring diagram (standard)" on page 13 and the ROPEX Application Report. The information provided in section 8.2 "Installation steps" on page 10 must be heeded additionally.
  5. Connect the RESISTRON temperature controller to the CAN master using a cable according to IEC 947-5-2.
- ⚠ Check the tightness of all the system connections, including the terminals for the impulse transformer windings.**
6. Make sure that the wiring conforms to the relevant national and international installation regulations.

## 8.2 Installation steps

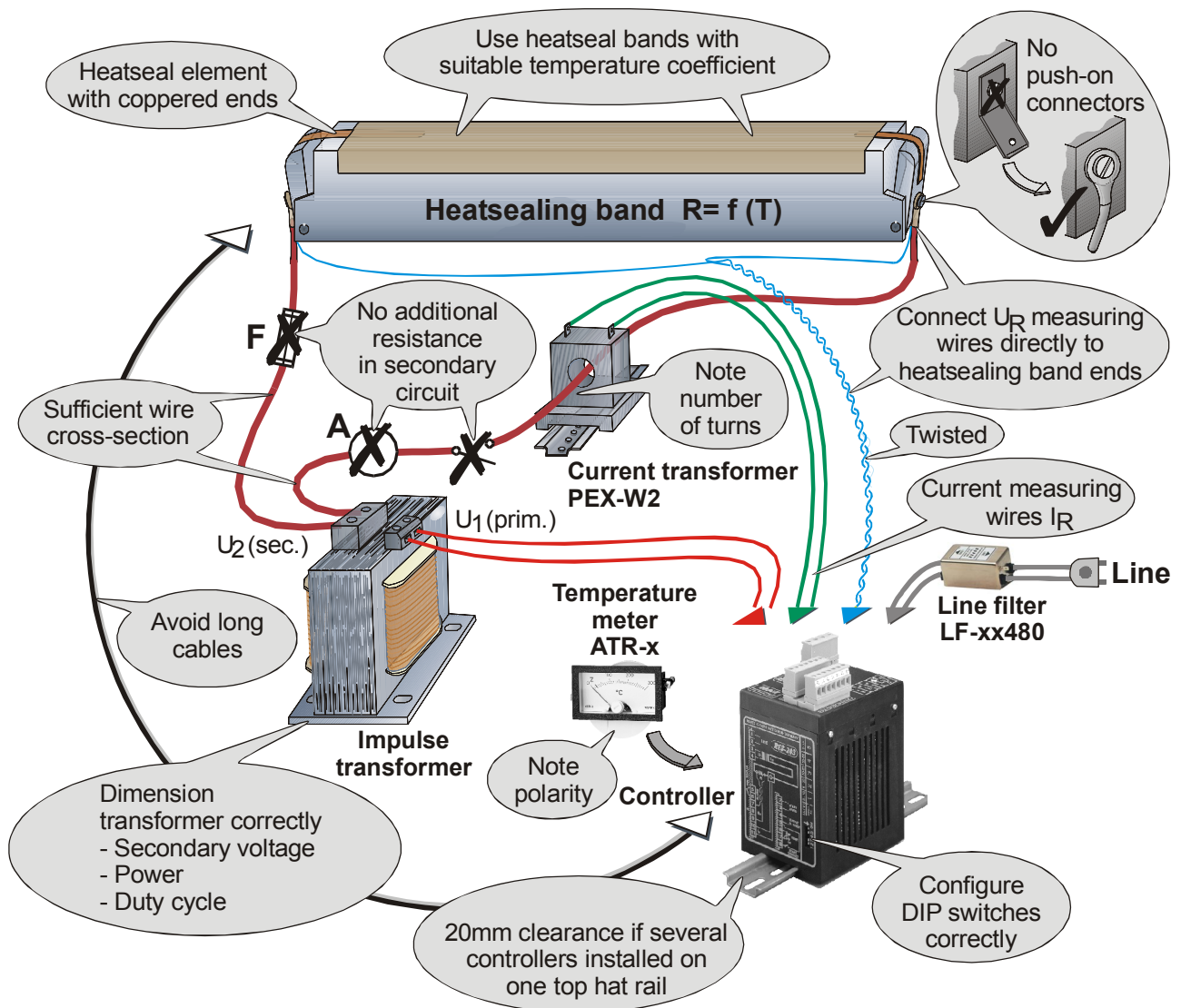

### 8.3 Power supply

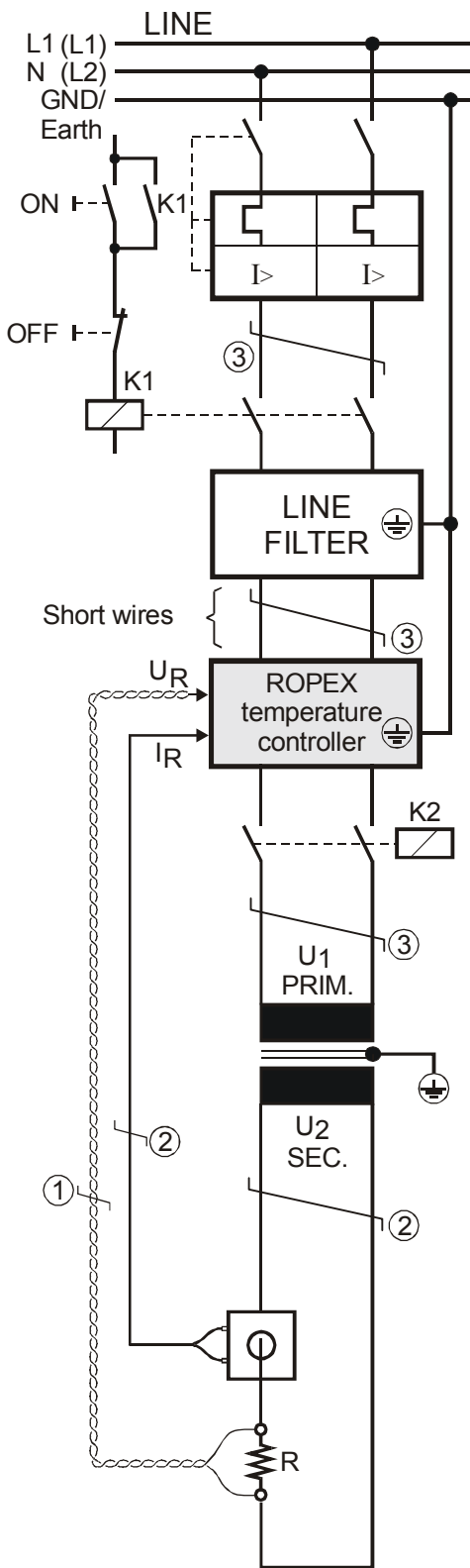

**Line**

115V AC, 230V AC, 400V AC

**Circuit breaker**

Double-pole, Z characteristic  
 Rated current: 16A, e.g. ABB-STOTZ, Type S282-Z16 (for all applications)

⚠ Short-circuit protection only.  
 RESISTRON temperature controller not protected.

**Relay K1**

For "HEAT ON - OFF" function (all-pole) or "EMERGENCY STOP".

**Line filter**

The filter type and size must be determined according to the load, the transformer and the machine wiring (☞ ROPEX Application Report).

⚠ Do not lay the filter supply wires (line side) parallel to the filter output wires (load side).

**RESISTRON temperature controller** belonging to the "series 4xx".

**Relay K2**

Load break (all-pole), e.g. in combination with the alarm output of the temperature controller.

**Impulse transformer**

Designed according to VDE 0570/EN 61558 (isolating transformer with reinforced insulation). Connect core to ground.

⚠ Use transformers with a one-section bobbin. The power, duty cycle and voltage values must be determined individually according to the application (☞ ROPEX Application Report and "Accessories" leaflet for impulse transformers).

**Wiring**

The wire cross-sections depend on the application (☞ ROPEX Application Report).

Guide values:

Primary circuit: min. 1.5mm<sup>2</sup>, max. 2.5mm<sup>2</sup>

Secondary circuit: min. 4.0mm<sup>2</sup>, max. 25mm<sup>2</sup>

- ① These wires must always be twisted (>20/m)
- ② These wires must be twisted (>20/m) if several control loops are laid together ("crosstalk").
- ③ Twisting (>20/m) is recommended to improve EMC.

## 8.4 Line filter

To comply with EMC directives – corresponding to EN 50081-1 and EN 50082-2 – RESISTRON control loops must be operated with line filters.

These filters damp the reaction of the phase-angle control on the line and protect the controller against line disturbances.

**! The use of a suitable line filter is part of the standards conformity and a prerequisite of the CE mark.**

and wired correctly, they guarantee compliance with the EMC limit values.

You can find the exact specification of the line filter in the ROPEX Application Report calculated for your particular heatsealing application.

For more technical information: ↪ "Line filter" documentation.

**! It is permissible to supply several RESISTRON control loops with a single line filter, providing the total current does not exceed the maximum current of the filter.**

ROPEX line filters are specially optimized for use in RESISTRON control loops. Providing they are installed

The wiring instructions contained in section 8.3 "Power supply" on page 11 must be observed.

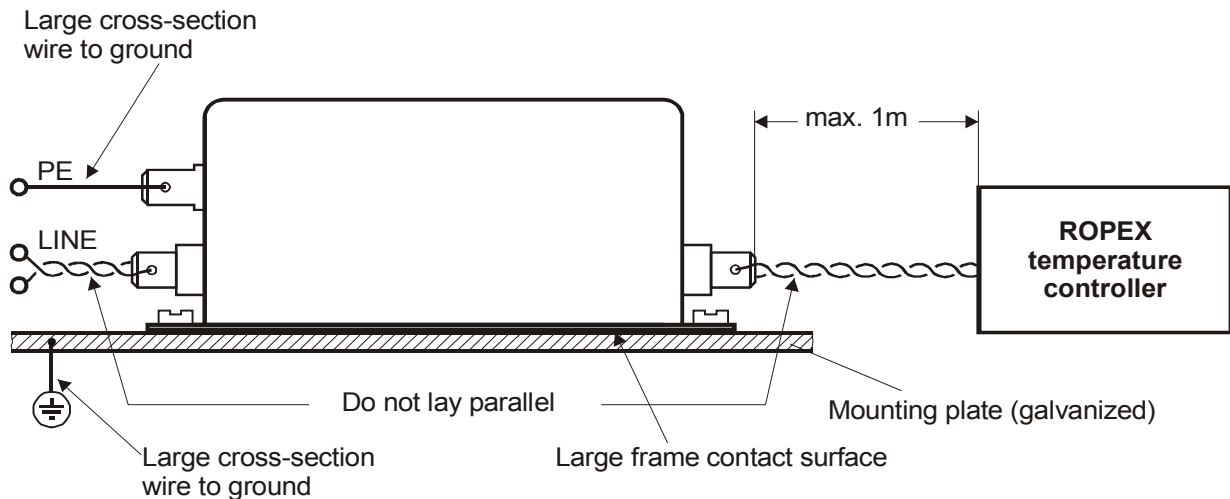

## 8.5 Current transformer PEX-W2

The PEX-W2 current transformer supplied with the RESISTRON temperature controller is an integral part

of the control system. The current transformer may only be operated if it is connected to the temperature controller correctly (↪ section 8.3 "Power supply" on page 11).

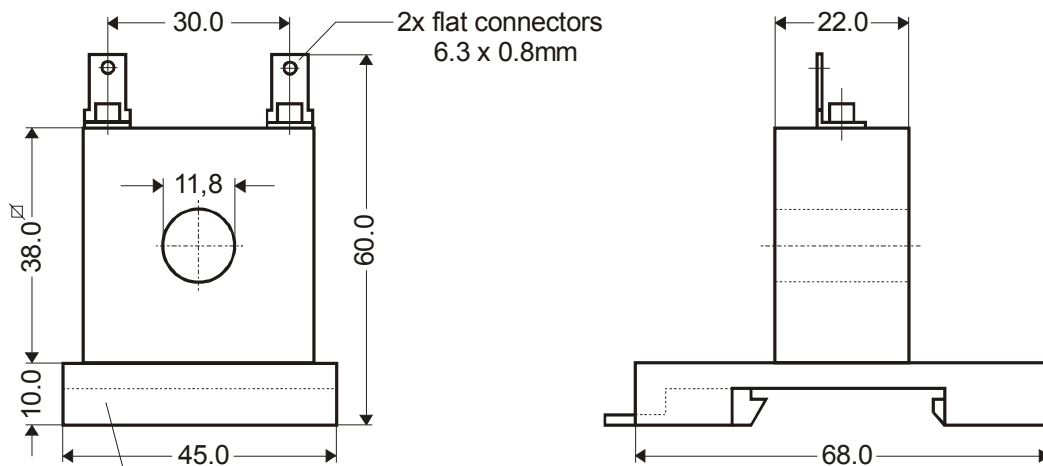

Snap-on plate for top hat rail (DIN TS35 rail), 35 x 7.5mm or 35 x 15mm, acc. DIN EN 50022

### 8.6 Wiring diagram (standard)

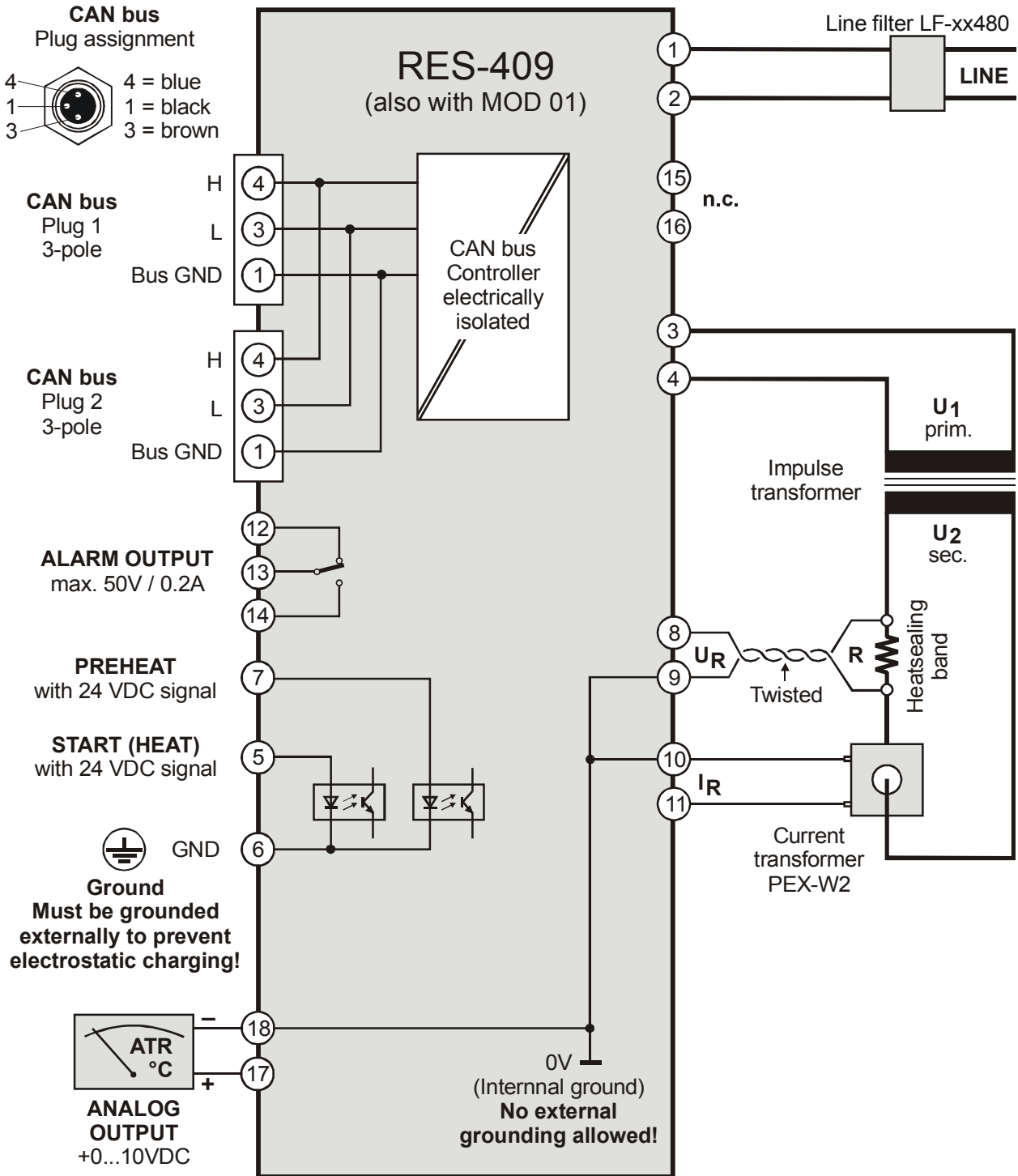

## 8.7 Wiring diagram with booster connection (MOD 26)

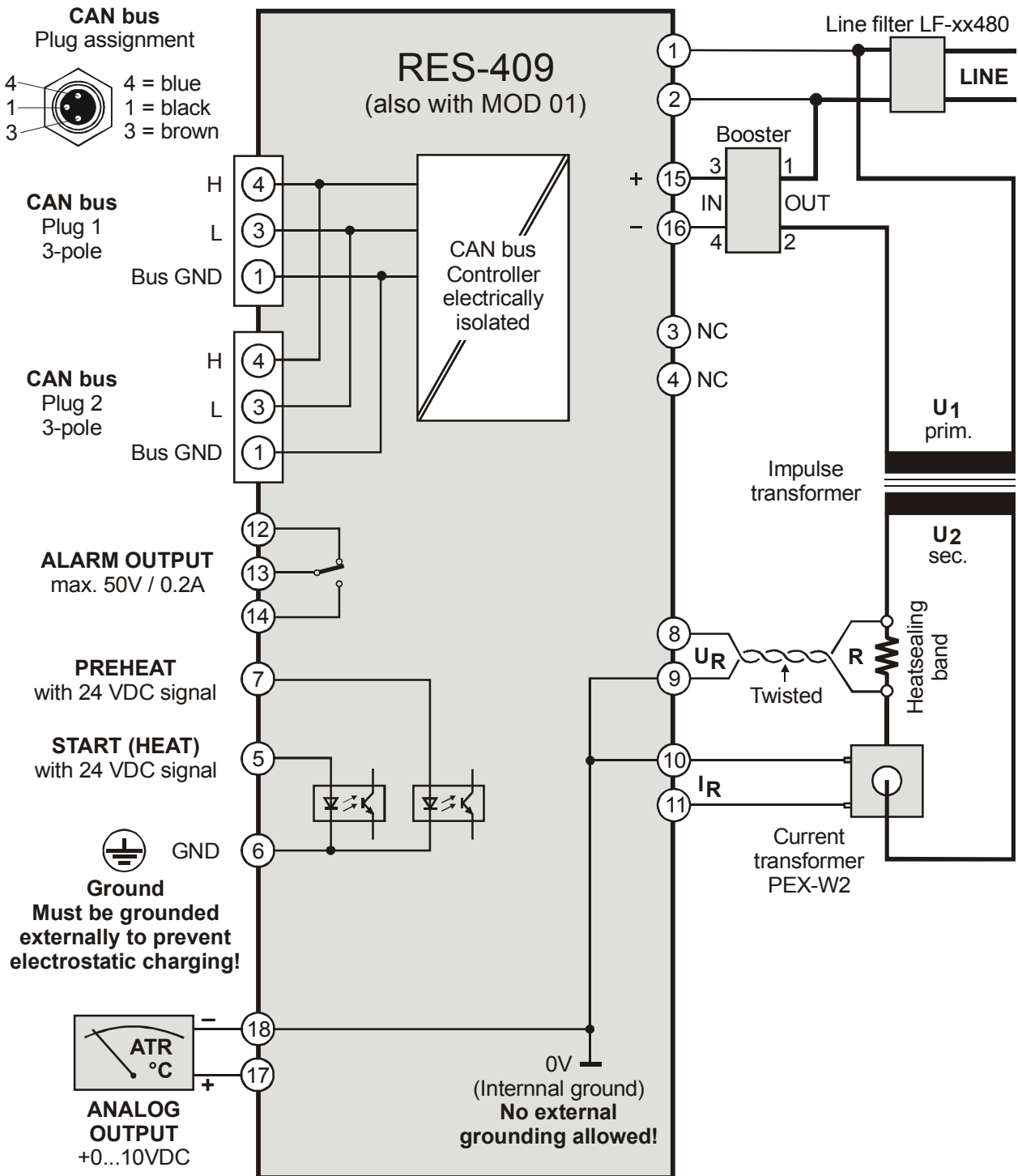

## 9 Startup and operation

### 9.1 View of the controller

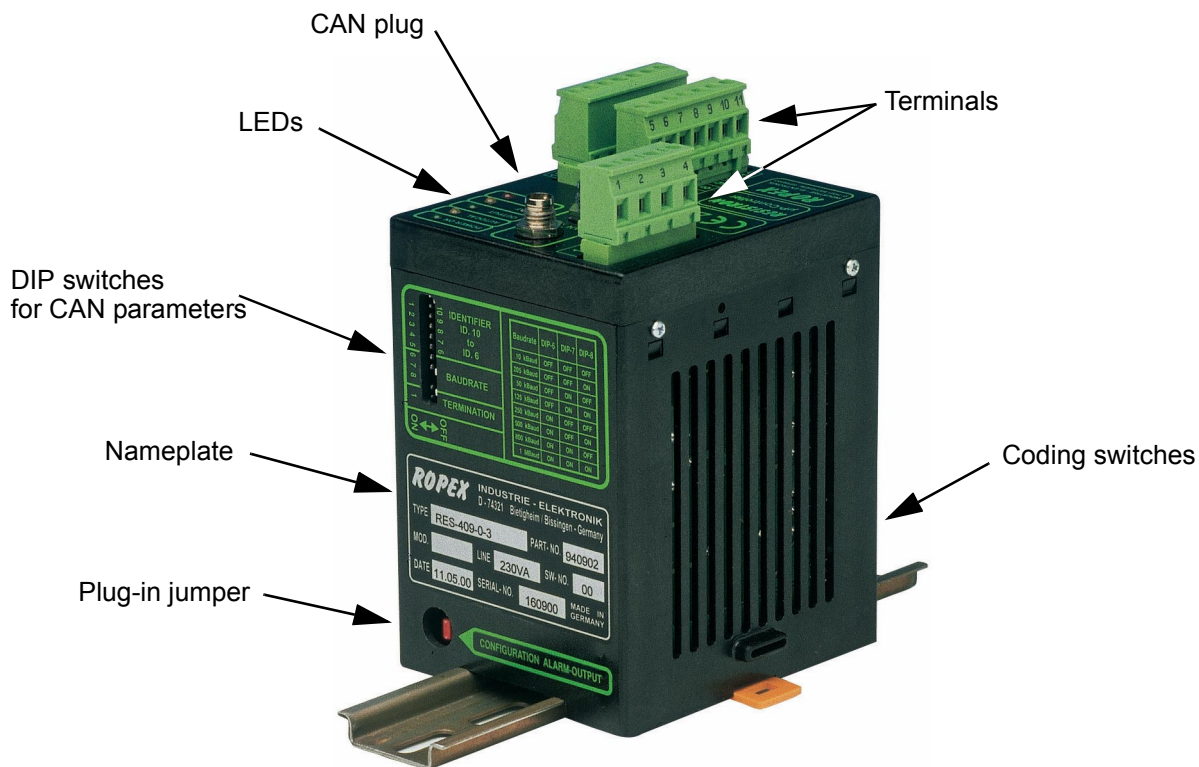

### 9.2 Controller configuration

**!** The controller must be switched off in order to configure the coding switches and plug-in jumpers.

#### 9.2.1 Configuration of the DIP switches for secondary voltage and current

Set the DIP switches for matching the secondary voltage  $U_2$  and the secondary current  $I_2$  to the correct position for **your** application.

**!** You can find the exact configuration of the DIP switches in the ROPEX Application Report calculated for your particular application.

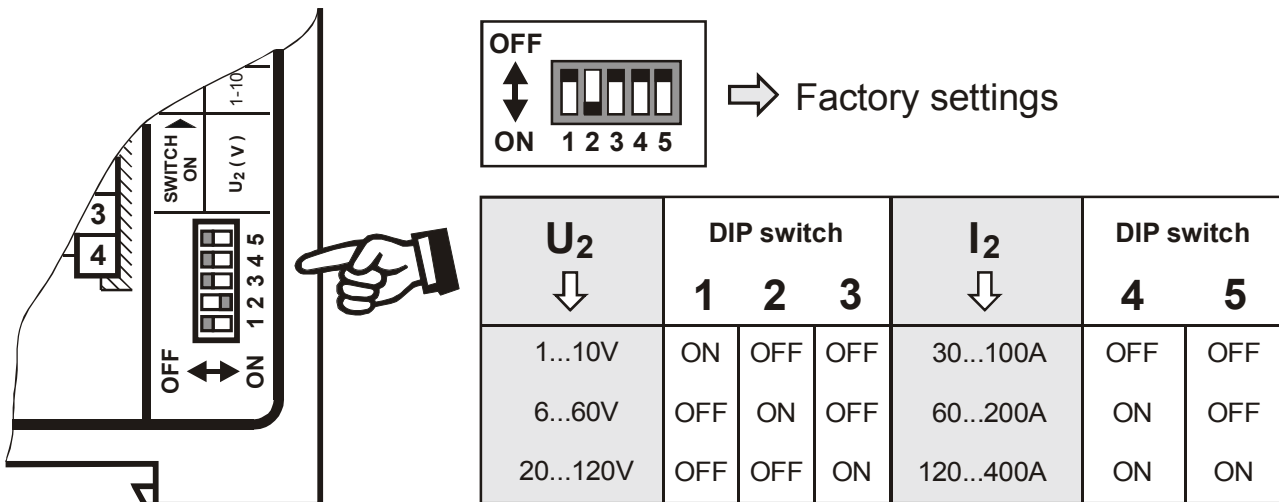

If the secondary current  $I_2$  is less than 30A, the PEX-W2 current transformer must have two turns (↪ ROPEX Application Report).



### 9.2.2 Configuration of the alarm relay

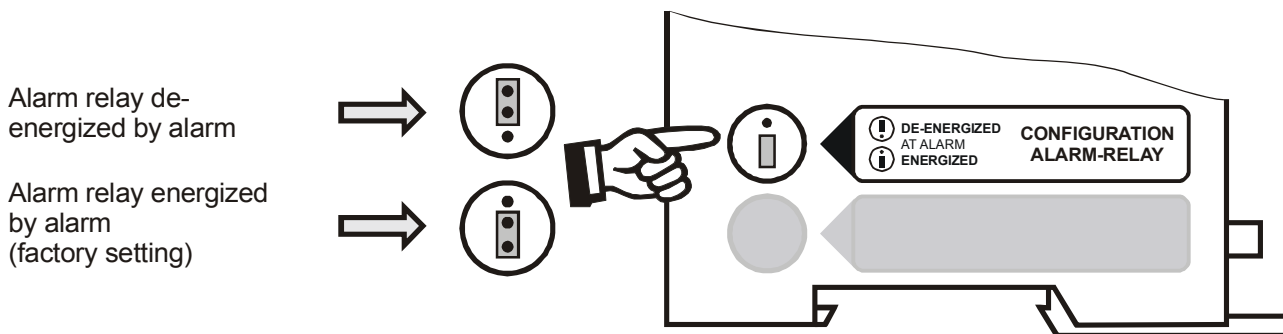

**⚠** If the jumper is not inserted, the alarm relay is permanently active (alarm contact between terminals 13 and 14 closed). The other functions of the controller (e.g. heating up, AUTOCAL etc.) are not impaired by this.



### 9.2.3 Configuration of the CAN interface

can be set. It is also possible to activate a terminating resistance.

The CAN interface of the RES-409 is configured with DIP switches. The baud rate and some of the identifiers

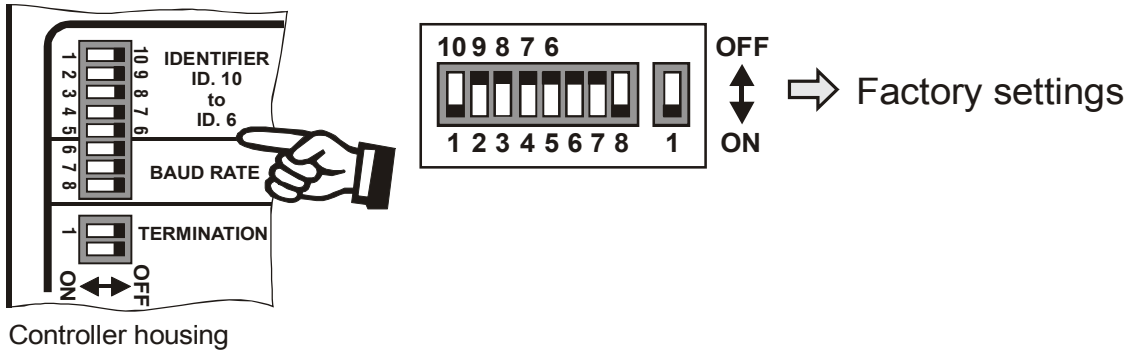

### 9.2.4 DIP switches for setting the baud rate

Various baud rates can be set with DIP switches 6 to 8. The switch positions for the available baud rates are shown in the table below:

Baud rate	DIP-6	DIP-7	DIP-8
10kBaud	OFF	OFF	OFF
205kBaud	OFF	OFF	ON
50kBaud	OFF	ON	OFF
125kBaud	OFF	ON	ON
250kBaud	ON	OFF	OFF
500kBaud	ON	OFF	ON
800kBaud	ON	ON	OFF
1MBaud	ON	ON	ON

### 9.2.5 DIP switches for setting the identifiers

Switches 5...1 of the 8-pole DIP switch determine the 5 high bits of the 11 bit long standard CAN identifier. The 6 low bits are fixed. Since the identifier 0 should not

be used, a maximum of 30 different controllers can be addressed in a CAN network.

The least significant identifier bit has a fixed value of 0 for receiving CAN messages:

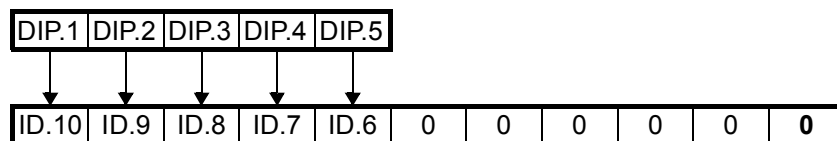

The least significant bit has a fixed value of 1 for sending CAN messages: The identifier for CAN messages sent by the RES-409, in other words, always

has a value one higher than for received CAN messages.

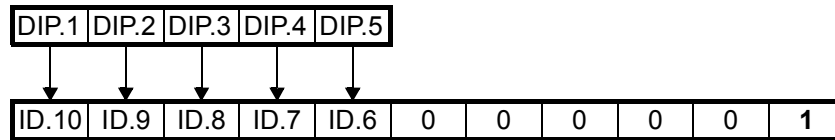

 **A new DIP switch setting does not take effect until the next time the controller is switched on.**

### 9.2.6 DIP switches for activating the terminating resistance

DIP switch no. 1 "Termination" can be used to switch a terminating resistance of 150ohms between the two CAN lines (CAN-L and CAN-H). The "Termination" switch must be set to "ON" in order to activate this resistance.

reduced by approximately 2...3%. However, this at first glance slight resistance change results in a zero point error of 20...30°C. The zero point must therefore be corrected after a few heating cycles (↪ section 9.3.2 "Burning in the heatsealing band" on page 18).

One very important design feature is the copper or silver-plating of the heatsealing band ends. Cold ends allow the temperature to be controlled accurately and increase the life of the teflon coating and the heatsealing band.

 **An overheated or burned-out heatsealing band must no longer be used because the TCR has been altered irreversibly.**

## 9.3 Heatsealing band

### 9.3.1 General

The heatsealing band is a key component in the control loop, since it is both a heating element and a sensor. The geometry of the heatsealing band is too complex to be discussed at length here. We shall therefore only refer to a few of the most important physical and electrical properties:

The measuring principle applied for this system necessitates a heatsealing band alloy with a suitable temperature coefficient TCR, i.e. one whose resistance increases as the temperature rises.

Too low a TCR leads to oscillation or uncontrolled heating.

When heatsealing bands with a higher TCR are used, the controller must be calibrated for this.

The first time the heatsealing band is heated to approximately 200...250°C, the standard alloy undergoes a once-only resistance change (burn-in effect). The cold resistance of the heatsealing band is

### 9.3.2 Burning in the heatsealing band

If a new heatsealing band has been used, the zero point is first of all calibrated while the band is still cold by activating the "AUTOCAL" function on the controller. When the "AUTOCAL" function has finished, the controller outputs the preselected calibration temperature (default value: 20°C) as the ACTUAL temperature at the analog actual value output as well as in the controller status. Adjust the set point to approximately 250°C and send a "START" command with a heating time of approximately 1 second (↪ section 10.3.2 "START/STOP command" on page 22). After recooling, the controller usually indicates a value less than 20°C. Repeat the "AUTOCAL" function. The heatsealing band has now been burned in and the change in the alloying properties stabilized.

The burn-in effect described here does not occur if the heatsealing band has already been thermally pretreated by the manufacturer.

### 9.3.3 Replacing the heatsealing band

All power supply leads must be disconnected from the RESISTRON temperature controller in order to replace the heatsealing band.

 **The heatsealing band must be replaced in accordance with the instructions provided by the manufacturer.**

Each time the heatsealing band is replaced, the zero point must be calibrated with the AUTOCAL function while the band is still cold, in order to compensate production-related resistance tolerances. The burn-in procedure described above must be performed for all new heatsealing bands.

## 9.4 Startup procedure

Please also refer to section 1 "Safety and warning notes" on page 3 and section 2 "Application" on page 4.

 **Installation and startup may only be performed by technically trained, skilled persons who are familiar with the associated risks and warranty provisions.**

### 9.4.1 Initial startup

Prerequisites: The controller must be correctly installed and connected (↪ section 8 "Installation" on page 9). Proceed as follows to start up the controller for the first time:

1. Switch off the line voltage and verify that all circuits are deenergized.
2. The supply voltage specified on the nameplate of the controller must be identical to the line voltage that is present in the plant or machine. The line frequency is automatically detected by the temperature controller in the range from 47 to 63Hz.
3. The settings of the coding switches on the controller depend on the ROPEX Application Report, the

required baud rate and the identifier in the CAN network (↪ section 9.2 "Controller configuration" on page 15).

4. Make sure that a START command is not sent.
5. When the voltage is switched on, the yellow "AUTOCAL" LED lights up for approximately 0.3 seconds to indicate that the controller is being powered up correctly.
6. One of the following states then appears:

"ALARM" LED	"OUTPUT" LED	ACTION
OFF	Shortpulses every 1.2s	Go to 7
BLINKS fast (4Hz)	OFF	Go to 7
LIT continuously	OFF	Fault diagnosis (↪ section 10.8)

7. Activate the AUTOCAL function while the heatsealing band is still cold by sending the CAN message address 4, value 5.
8. Burn in the heatsealing band (↪ section 9.3 "Heatsealing band" on page 18) and repeat the AUTOCAL function.

**The controller is now ready**

### 9.4.2 Restart after replacing the heatsealing band

To replace the heatsealing band, proceed as described in section 9.3 "Heatsealing band" on page 18.

 **Always use a heatsealing band with the correct alloy, dimensions and copper-plating in order to avoid malfunctions and overheating.**

Continue with section 9.4, steps 4 to 8.

## 10 Controller functions

### 10.1 Indicators and controls

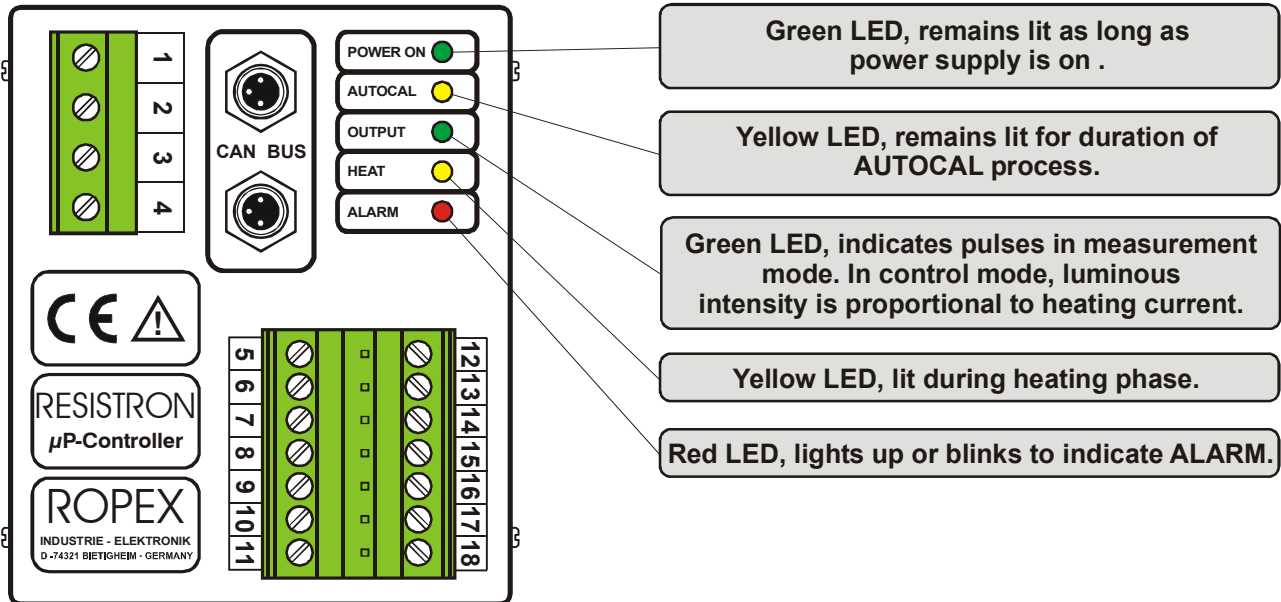

The following sections describe only controller-specific functions. For general information about the CAN bus and the system configuration, please refer to the description of your PLC.

### 10.2 CAN protocol

The CAN messages of the RES-409 always consist of 4 bytes. The first two bytes form a 16 bit address and the last two a 16 bit value:

Address.H	Address.L	Value.H	Value.L
Byte 1	Byte 2	Byte 3	Byte 4

"Address.H" is the first byte to be transferred while "value L" is transferred last.

### 10.3 Receiving CAN messages

The complete command set of the RES-409 is shown in the table below:

Address	Value	Meaning
0000	0... $T_{max}$	Store set point 0 (in °C)
0001	0... $T_{max}$	Store set point 1 (in °C)
0002	0... $T_{max}$	Store set point 2 (in °C)
0003	0... $T_{max}$	Store set point 3 (in °C)
0004	0 1 2 3 4 5 6 7 8 9 10 11 12	Query set point 0 (in °C) Query set point 1 (in °C) Query set point 2 (in °C) Query set point 3 (in °C) Query controller status Execute "AUTOCAL" function Execute "Reset" after alarm Query current actual value Query controller number, part 1 Query controller number, part 2 Query calibration temperature Query temperature monitoring value Query current controller version (heatsealing band alloy/temperature range)
0005	Heating time and set point	START with preselected heating time and set point selection Premature STOP if heating time = 0
0006	0...40	Store calibration temperature (in °C)
0007	3...20	Store temperature monitoring value (in K)
0008	0 1 2 3 4 5	Store controller version (heatsealing band alloy/temperature range): TCR = 1100ppm, max. temperature range 200 °C TCR = 1100ppm, max. temperature range 300 °C TCR = 1100ppm, max. temperature range 400 °C TCR = 1100ppm, max. temperature range 500 °C TCR = 3500ppm, max. temperature range 200 °C TCR = 3500ppm, max. temperature range 300 °C

#### 10.3.1 Temperature setting (set point selection)

Up to four different set points can be permanently stored in the RES-409. The stored values are not lost if the power supply is interrupted. They can be reloaded on request. It is possible to switch between preheat and main heat, for instance, or to increase the temperature to a particular set point gradually in a series of steps ("ramp") simply by programming the set points accordingly. The maximum settable set point  $T_{max}$  is dependent on the selected controller version (see CAN

message address 8 and CAN message address 4, value 12). Temperature ranges of 200°C, 300°C, 400°C and 500°C can be defined. If a maximum temperature range of 0...300°C is selected, for example, all set points greater than 300°C will be rejected by the RES-409. In this case, the last stored set point remains valid.

The set point that is selected for the heatsealing temperature must be greater than 40°C. If not, the heatsealing band will not be heated up when the start/stop command is activated.

### 10.3.2 START/STOP command

The "value" parameter in the START command (address 5) has the following structure:

Bit no.	Name	Meaning
Bits 0...7	Heating time	Time in 10ms resolution until the control process is automatically deactivated (at least 50ms).
Bits 8...9	Set point	Number of the required set point (0...3)
Bits 10...15	Not assigned	

START is only accepted if there are no alarms and the "AUTOCAL" function is not executing (☞ 10.4.1). The number of the required set point and the maximum heating time (50ms...2550ms) are transferred together with the START command. If the controller must heat for longer than 2550ms (e.g. for continuous heating), a new START command must be sent before the end of the heating time. This mechanism ensures that the controller does not heat in an uncontrolled way for long periods if there is no CAN communication. The heating phase can be aborted by sending a START command with a heating time < 5 (corresponds to 50ms), whereby the set point number is irrelevant. The controller then terminates the heating phase immediately and changes to measuring mode.

Each START/STOP command is answered with an acknowledgment message (address 9), which also contains the 6 low bits of the controller status in addition to the actual temperature value.

### 10.3.3 Automatic zero calibration (AUTOCAL)

Owing to the automatic zero calibration (AUTOCAL) function, there is no need to adjust the zero point manually on the controller. The "AUTOCAL" function matches the controller to the current and voltage signals that are present in the system.

The automatic calibration process takes around 10...15 seconds. The heatsealing band is not heated until the calibration process has finished.

The valid initial temperature (ambient temperature) of the heatsealing bar(s) which is currently valid for calibration can be set in the 0...40°C range. The CAN message "Store calibration temperature" (address 6, receive) is used for this purpose. The last stored calibration temperature is displayed with the CAN message "Actual calibration temperature (address 8, send). The default value is 20°C.

The CAN message for starting the "AUTOCAL" function (address 4, value 5) is executed by the

controller immediately providing the "AUTOCAL" function is not disabled. The controller reports "AUTOCAL active" in the status.

#### Reasons for disabled "AUTOCAL" function:

1. The "AUTOCAL" function cannot be activated if the heatsealing band cools down at a rate of more than 0.1K/s.
2. The "AUTOCAL" function is not executed until the end of the heating time.
3. Directly after the controller is powered up, the AUTOCAL function cannot be activated if a fault with error code 1...3 or 5...7 occurs (☞ section 10.7 "Error messages" on page 27). If the controller has already operated correctly - a minimum of once - after powering up, the AUTOCAL function cannot be activated with error codes 5...7.

If the "AUTOCAL" function is temporarily disabled, the request is stored. As soon as "AUTOCAL" is possible again, the function is started and "AUTOCAL active" is displayed in the status.

If a START or STOP command is received between the "AUTOCAL" request and the actual start of the "AUTOCAL" function, the "AUTOCAL" request is canceled again and the START or STOP command is executed.

### 10.3.4 Temperature monitoring

The RES-409 checks in control mode (START is active) whether the ACTUAL temperature is within a settable tolerance band ("OK" window) either side of the set temperature. The lower and upper tolerance band limits ( $\Delta\vartheta$ ) can be changed between 3 and 20°C with the CAN message address 7.

If the ACTUAL temperature is inside the specified tolerance band, the "Temperature OK" bit (bit 3) is set in the controller status:

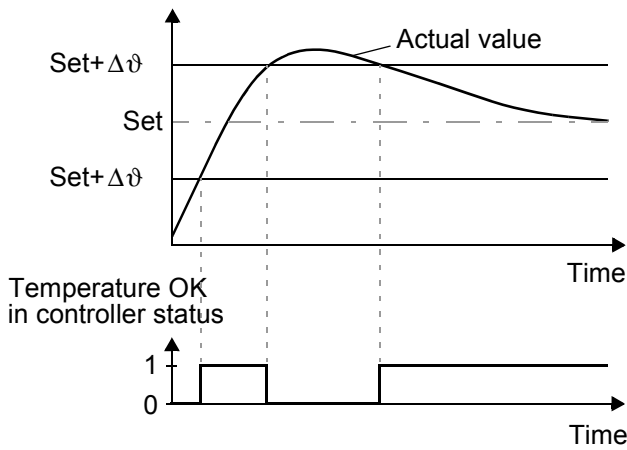

As soon as the control mode is exited (heating time elapsed or STOP command sent), the "Temperature OK" bit is reset again in the controller status.

### 10.3.5 Controller version (heatsealing band alloy/temperature range)

The RES-409 can be configured for different heatsealing band alloys and temperature ranges ( $T_{max}$ ) with the CAN message address 8. The set controller version is permanently stored in the controller and is not lost even if the power supply fails. The current setting can be reloaded by means of the CAN message address 11. The controller is delivered with the setting 1, in other words  $TCR = 1100ppm$  and a maximum temperature  $T_{max} = 300^{\circ}C$ .

If a set point which is higher than the maximum permissible temperature is selected, it is limited to the maximum value.

The scale of the analog output for the ACTUAL temperature is dependent on the selected maximum temperature:

Temperature range	Scale
200 °C and 300 °C	0...10VDC (corresponds to 0...300 °C)
400 °C and 500 °C	0...10VDC (corresponds to 0...500 °C)

**!** You must always execute the **AUTOCAL** function after changing the controller version.

### 10.3.6 Reset

This command is used to reset the controller. If the controller reports an alarm (↪ section 10.4.1 "Controller status" on page 24), it must be reset with this command (and possibly also with the AUTOCAL command).

If a communication problem occurs, the controller must be reset by briefly disconnecting it from the power supply.

**!** The controller executes an internal initialization run lasting approximately 500ms after the "RESET" command is received. The next heatsealing process cannot be started until it has finished.

**!** If a contactor K2 is used to deactivate the control loop (↪ section 8.3 "Power supply" on page 11), it must be energized again 50ms at the latest after the "RESET" command is received. If it is energized too late, an alarm signal will be output by the controller.

### 10.3.7 Querying the ACTUAL temperature

The RES-409 responds to a command to query the actual value with the value of the current ACTUAL temperature in °C. Negative temperatures are identified by the "sign" bit (most significant bit).

## 10.4 Sending CAN messages

The send command set of the RES-409 is shown in the table below:

Address	Value	Meaning
0000	0...T <sub>max</sub>	Current set point 0 (in °C)
0001	0...T <sub>max</sub>	Current set point 0 (in °C)
0002	0...T <sub>max</sub>	Current set point 0 (in °C)
0003	0...T <sub>max</sub>	Current set point 0 (in °C)
0004	-20...T <sub>max</sub>	Current actual value (in °C)
0005	(↪ 10.4.1)	Current, full controller status
0006	3 digits (BCD coded)	Digits 1...3 of the 6-digit controller number
0007	3 digits (BCD coded)	Digits 4...6 of the 6-digit controller number
0008	0...40	Current calibration temperature (in °C)
0009	(↪ 10.4.2)	Acknowledgment message (current actual value with reduced controller status)
0010	3...20	Current temperature monitoring value
0011	0...5 (↪ 10.3)	Current controller version (heatsealing band alloy/temperature range)

### 10.4.1 Controller status

The controller status is sent on request. It contains all important information about the controller. If an alarm is signaled, the fault can be diagnosed accurately with the

help of the alarm code (↪ section 10.7 "Error messages" on page 27).

The controller status is coded as follows:

Bit no.	Name	Meaning
0...1	Set point no.	Number of the last set point used (0...3)
2	Controller active	0: Measuring mode 1: Control mode
3	Temperature OK	0: Actual value outside the specified temperature monitoring band 1: Actual value inside the specified temperature monitoring band
4	Alarm	0: No alarm 1: Alarm active
5	AUTOCAL disabled	0: "AUTOCAL" function possible 1: "AUTOCAL" function not possible (cooling-down phase)
6	AUTOCAL active	0: "AUTOCAL" function not executing 1: "AUTOCAL" function executing
7	Not assigned	
8...11	Alarm code	Alarm code 0...12 (↪ section 10.7 "Error messages" on page 27)
12...15	Not assigned	



### 10.4.2 Acknowledgment message

The RES-409 automatically sends an acknowledgment message (address 9) after every START/STOP

command. This message contains the current actual value and the most important status information:

Bit no.	Name	Meaning
0...8	Actual value	Current actual value (in °C)
9	Sign	Sign of the actual value. 0: positive, 1: negative
10...11	Set point no.	Number of the last set point used (0...3)
12	Controller active	0: Measuring mode 1: Control mode
13	Temperature OK	0: Actual value outside the specified temperature monitoring band 1: Actual value inside the specified temperature monitoring band
14	Alarm	0: No alarm 1: Alarm active
15	AUTOCAL disabled	0: "AUTOCAL" function possible 1: "AUTOCAL" function not possible (cooling-down phase)

The controller number is assigned individually to each controller and can be used to uniquely identify the RESISTRON temperature controller in a CAN network. It is subdivided into two parts, in order to comply with the message format (☞ section 10.2 "CAN protocol" on page 20). Each part consists of three digits, which are stored in BCD format in "value.H" and "value.L".

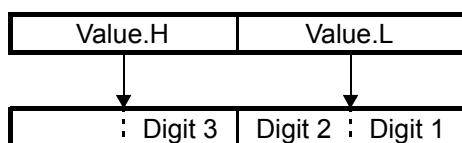

### 10.5 Temperature indication (actual value output)

The RES-409 supplies an analog 0...10VDC signal, which is proportional to the real ACTUAL temperature, at terminals 17+18.

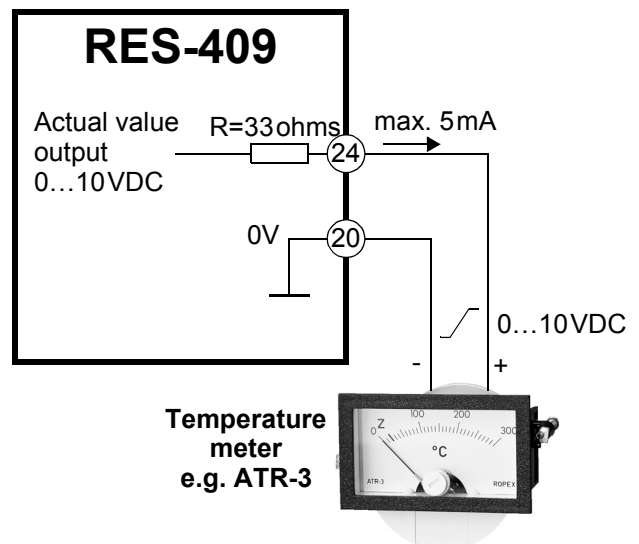

Voltage values:  
 0VDC → 0°C  
 10VDC → 300°C or 500°C  
 (depending on controller configuration)

The relationship between the change in the output voltage and the ACTUAL temperature is linear.

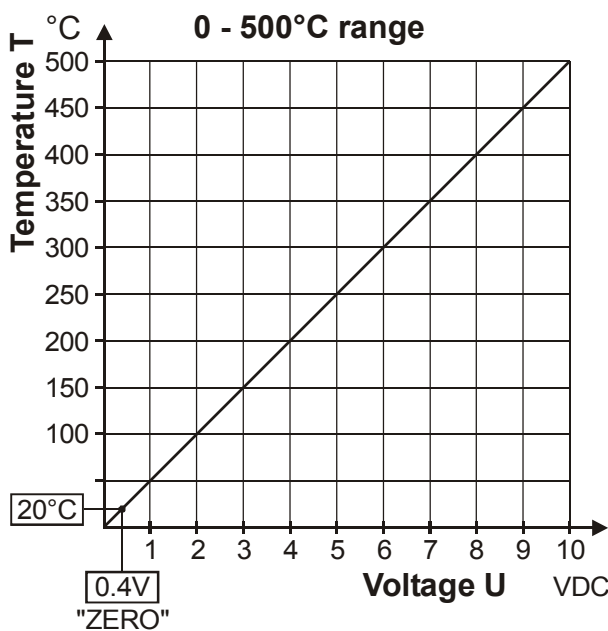
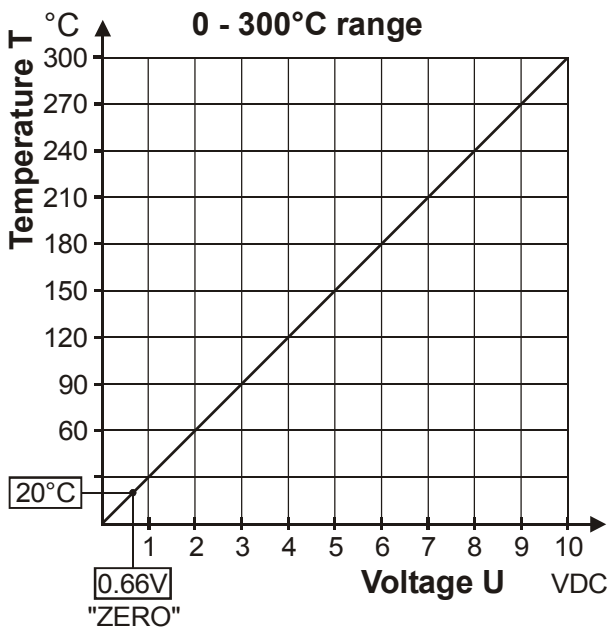

Only the 300°C and 500°C temperature ranges appear at this actual value output. If a temperature range of 200°C is set with the CAN message "Controller version", it appears at this output in the 0...300°C range. A 400°C temperature range is indicated as 0...500°C.

An indicating instrument can be connected to this output in order to visualize the temperature of the heatsealing band.

The characteristics of the ROPEX ATR-x temperature meter (size, scaling, dynamic response) are ideally suited to this application and this instrument should therefore always be used (☞ section 5 "Accessories and modifications" on page 6).

It not only facilitates SET-ACTUAL comparisons, but also enables other criteria such as the heating rate, set point reached within the specified time, cooling of the heatsealing band etc. to be evaluated.

This meter moreover permits disturbances in the control loop (loose connections, contacting or wiring problems) as well as any line disturbances to be monitored extremely effectively and interpreted accurately. The same applies if mutual interference occurs between several neighboring control loops.

**⚠ This output is not potential-free and can carry the potential of the secondary voltage of the impulse transformer. External grounding is not allowed. If this warning is ignored, the controller will be damaged by frame currents. Shock protection must be provided.**

If an alarm is signaled, this analog output is used to display a selective error message (☞ section 10.7 "Error messages" on page 27).

## 10.6 System monitoring/alarm output

To increase operating safety and to avoid faulty heatsealing, the controller incorporates special hardware and software features that facilitate selective fault detection and diagnosis. Both the external wiring and the internal system are monitored.

These features crucially support the system owner in localizing the cause of an abnormal operating state.

A system fault is reported or differentiated by means of the following elements.

### A.) Red "ALARM" LED on the controller lights up with three states:

#### 1. Blinking fast (4Hz)

This means that the AUTOCAL function should be executed (error codes 8+9).

#### 2. Blinking slowly (1Hz)

This means that the system configuration is incorrect and that the zero calibration (AUTOCAL function) must have been unsuccessful (↪ section 9.2 "Controller configuration" on page 15). It corresponds to error codes 10 to 12.

#### 3. Lit continuously:

This indicates a fault that is preventing the controller from being started up (error codes 1 to 7).

As a rule, it refers to an external wiring fault.

### B.) Alarm relay (relay contact terminals 12+13+14):

The alarm relay is set in the factory as follows:

- **NOT ACTIVE** in operating states A.1 and A.2, but active if a "START" signal is activated in one of these states.
- **ACTIVE** in operating state A.3.

If the alarm relay is configured differently from the factory setting (↪ section 9.2.2 "Configuration of the alarm relay" on page 16), these states are inverted.

### C.) Error code output via the CAN protocol

If an error occurs, the alarm bit is set in the controller status (bit 4) (↪ section 10.4.1 "Controller status" on page 24) and in the acknowledgment message (bit 14) (↪ section 10.4.2 "Acknowledgment message" on page 25). The alarm code appears at bit positions 8...11 in the controller status.

### D.) Error code output via the 0 to 10VDC actual value output (terminals 17+18):

Since a temperature indication is no longer necessary if a fault occurs, the actual value output is used to display error codes in the event of an alarm.

12 voltage levels are offered for this purpose in the 0...10VDC range, each of which is assigned an error code (↪ section 10.7 "Error messages" on page 27).

If a state that requires "AUTOCAL" occurs - or if the controller configuration is incorrect - (error codes 8...12), the actual value output jumps back and forth at 1Hz between the voltage value that corresponds to this error and the end of the scale (10V DC, i.e. 300°C or 500°C). If the "START" signal is activated in one of these states, the voltage value does not change any more.

Selective fault detection and indication can thus be implemented simply and inexpensively using the analog input of a PLC with a corresponding error message (↪ section 10.7 "Error messages" on page 27).

## 10.7 Error messages

The table below shows how the analog voltage values correspond to the faults that have occurred. It also describes each fault and the required corrective action. The block diagram in section 10.8 "Fault areas and causes" on page 29 permits each fault to be cleared quickly and efficiently.

Error code	Act. value output; Voltage [V]	Temp. 300 °C [°C]	Temp. 500 °C [°C]	ALARM LED	STATUS of alarm relay (factory set.)	Cause	Action if machine started for first time	Action if machine already operating, HS-band not chang.
1	0.66	20	33	Lit Continuously	Closed	I <sub>R</sub> signal missing	Fault area ①	Fault area ①
2	1.33	40	66			U <sub>R</sub> signal missing	Fault area ③	Fault area ③
3	2.00	60	100			U <sub>R</sub> and I <sub>R</sub> signals missing	Fault area ②	Fault areas ② ⑨
4	2.66	80	133			Temperature step	Fault areas ④ ⑤ ⑥ (loose contact)	Fault areas ④ ⑤ ⑥ (loose contact)
5	3.33	100	166			Frequency fluctuation, inadmissible line frequency	Check power supply	Check power supply
6	4.00	120	200			Internal fault	Run RESET	Run RESET
7	4.66	140	233			Internal fault, controller defective	Replace controller	Replace controller
8	5.33 ↕ 10 ⤴	160 ↕ 300 ⤴	266 ↕ 500 ⤴	Blinking fast (4Hz)	Open, does not close until "START" signal (voltage value at analog output then no longer changes)	U <sub>R</sub> and/or I <sub>R</sub> signal incorrect	Run AUTOCAL	Fault areas ④ ⑤ ⑥
9	6.00 ↕ 10 ⤴	180 ↕ 300 ⤴	300 ↕ 500 ⤴			Data error	Run AUTOCAL	---
10	6.66 ↕ 10 ⤴	200 ↕ 300 ⤴	333 ↕ 500 ⤴	Blinking slowly (1Hz)		I <sub>R</sub> signal incorrect, calibration not possible	Fault area ⑧, check configuration	---
11	7.33 ↕ 10 ⤴	220 ↕ 300 ⤴	366 ↕ 500 ⤴			U <sub>R</sub> signal incorrect, calibration not possible	Fault area ⑦, check configuration	---
12	8.00 ↕ 10 ⤴	240 ↕ 300 ⤴	400 ↕ 500 ⤴			U <sub>R</sub> and I <sub>R</sub> signals incorrect, calibration not possible	Fault areas ⑦ ⑧, check configuration	---

### 10.8 Fault areas and causes

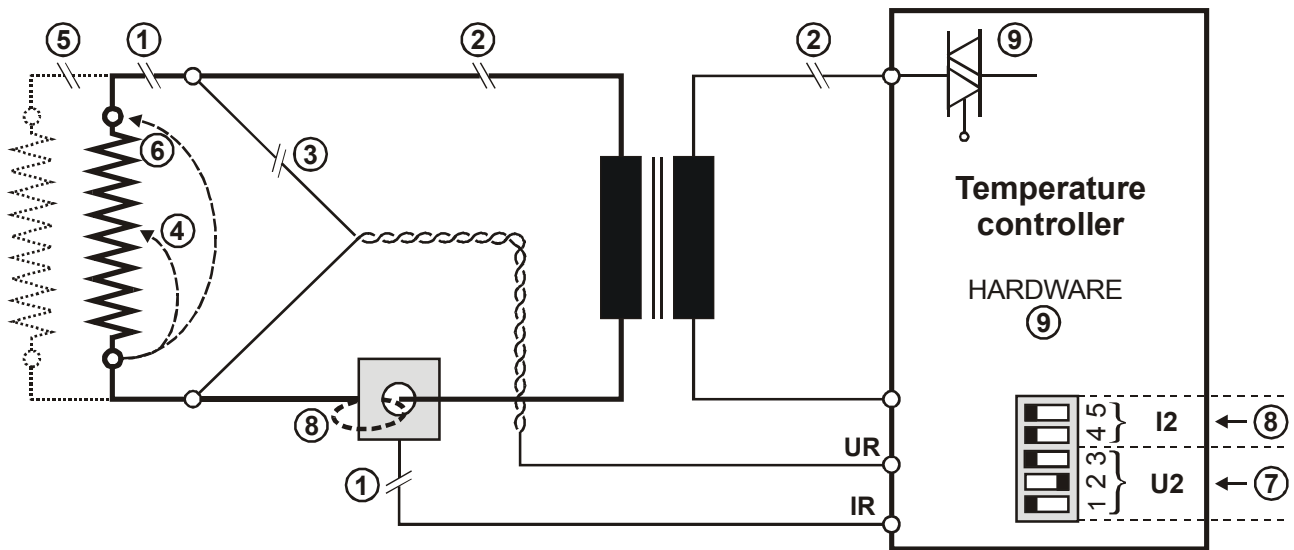

The table below explains the possible fault causes.

Fault area	Explanation	Possible causes
①	Load circuit interrupted after $U_R$ pickoff point	- Wire break, heatsealing band break - Contact to heatsealing band defective
	PEX-W2 current transformer signal interrupted	- $I_R$ measuring wires from current transformer interrupted
②	Primary circuit interrupted	- Wire break, triac in controller defective - Primary winding of impulse transformer interrupted
	Secondary circuit interrupted before $U_R$ pickoff point	- Wire break - Secondary winding of impulse transformer interrupted
③	$U_R$ signal missing	- Measuring wires interrupted
④	Partial short-circuit ( $\Delta R$ )	- Heatsealing band partially bypassed by conducting part (clamp, opposite heatsealing bar etc.)
⑤	Parallel circuit interrupted	- Wire break, heatsealing band break - Contact to heatsealing band defective
⑥	Total short-circuit	- Heatsealing band installed incorrectly, insulation at heatsealing bar ends missing or incorrectly installed - Conducting part bypasses heatsealing band completely
⑦	$U_R$ signal incorrect	- DIP switches 1 - 3 configured incorrectly ( $U_2$ range)
⑧	$I_R$ signal incorrect	- DIP switches 4 + 5 configured incorrectly ( $I_2$ range)
	Turns through PEX-W2 current transformer incorrect	- Check number of turns (two or more turns required for currents < 30A)
⑨	Internal controller fault	- Hardware fault (replace controller)

## 11 Factory settings

The RESISTRON temperature controller RES-409 is configured in the factory as follows:

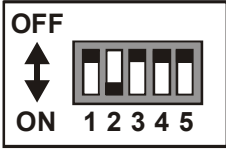
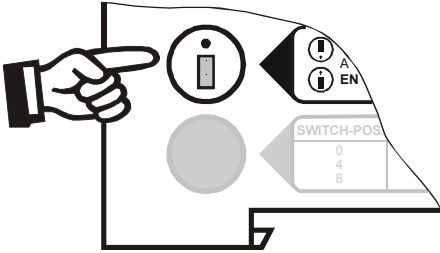
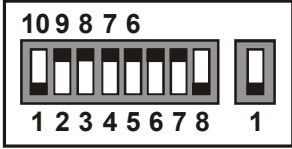





<p><u>DIP switches</u> for secondary voltage <math>U_2</math> and current <math>I_2</math></p>		<p><math>U_2 = 6...60VAC</math> <math>I_2 = 30...100A</math></p> <p>DIP switches: 2 ON 1, 3, 4, 5 OFF</p>
<p><u>Plug-in jumper</u> for alarm relay</p>		<p>Alarm relay energized by alarm</p>
<p><u>DIP switches</u> for identifier and baud rate</p>		<p>Identifier = 1024<sub>dec</sub> Baud rate = 205kBaude Termination = ON</p>

## 12 Maintenance

The controller requires no special maintenance. Regular inspection and/or tightening of the terminals – including the terminals for the winding connections on

the impulse transformer – is recommended. Dust deposits on the controller can be removed with dry compressed air.

### 13 How to order

	<p><b>Contr. RES - 409 / . . . VAC</b></p> <ul style="list-style-type: none"> <li>→ <b>115:</b> Power supply 115VAC, Art. No. 740901</li> <li>→ <b>230:</b> Power supply 230VAC, Art. No. 740902</li> <li>→ <b>400:</b> Power supply 400VAC, Art. No. 740903</li> </ul> <p>Scope of supply: Controller includes connector plug-in parts (without current transformer)</p> <p><b>Modification MOD . . (optional, if required)</b></p> <ul style="list-style-type: none"> <li>→ e.g. <b>01:</b> MOD 01, Art. No. 800001 (amplifier for low voltage)</li> </ul> <p>Please indicate the article numbers of the controller and the required modifications (optional) in all orders,  e.g. RES-409/400VAC + MOD 01  (controller for 400VAC power supply with amplifier for low voltage)  Art. No. 740903 + 800001 must be ordered</p>
	<p><b>Current transformer PEX-W2</b>  Art. No. 885104</p>
	<p><b>Line filter LF- . . 480</b></p> <ul style="list-style-type: none"> <li>→ <b>06:</b> Continuous current 6A, 480VAC, Art. No. 885500</li> <li>→ <b>35:</b> Continuous current 35A, 480VAC, Art. No. 885506</li> </ul>
	<p><b>Impulse transformer</b></p> <p>See ROPEX Application Report for design and ordering information</p>
	<p><b>Temp. meter ATR- .</b></p> <ul style="list-style-type: none"> <li>→ <b>3:</b> 300°C range, Art. No. 882130</li> <li>→ <b>5:</b> 500°C range, Art. No. 882150</li> </ul>
	<p><b>Booster B- . . . 400</b></p> <ul style="list-style-type: none"> <li>→ <b>075:</b> Max. pulse load 75A, 400VAC, Art. No. 885301</li> <li>→ <b>100:</b> Max. pulse load 100A, 400VAC, Art. No. 885304</li> </ul>

## 14 Index

### A

ACTUAL temperature 23  
 Actual value output 25  
 Alarm output 27  
 Alarm relay 8, 16  
 Alloy 19, 23  
 Ambient temperature 8  
 Analog temperature meter 6  
 Application 4  
 Application Report 10, 12, 15  
 AUTOCAL 6, 19, 22  
 Automatic zero calibration 6, 19  
 AUTOTUNE 6

### B

Booster 7, 14, 31  
 Burning in heatsealing band 18

### C

CAN interface 8  
 CAN messages  
     Receiving 21  
     Sending 24  
 CAN protocol 20  
 Circuit breaker 11  
 Controller status 24  
 Current transformer 12, 31

### D

Degree of protection 8  
 Digital temperature meter 6  
 DIP switches 15

### E

Error messages 27  
 External switching amplifier 7, 14

### F

Factory settings 30  
 Fault areas 29  
 Fault diagnosis 6

### H

Heatsealing band alloy 23  
 Heatsealing band type 8

### I

Impulse heatsealing method 4

Impulse transformer 7, 11, 31  
 Installation 8, 9  
 Installation procedure 9  
 Installation regulations 10

### L

Line filter 6, 11, 12, 31  
 Line frequency 6, 8  
 Line voltage 8

### M

Maintenance 30  
 Modifications (MODs) 7, 31  
 MODs 7, 31

### O

Overheating of heatsealing band 6

### P

PEX-W2 12, 31  
 Power supply 11, 31  
 Principle of operation 5

### R

Reasons for disabled "AUTOCAL" function 22  
 Replacing heatsealing band 19  
 Reset 23

### S

Secondary current  $I_2$  15  
 Secondary voltage  $U_2$  15  
 Set point selection 21  
 START/STOP command 22  
 System monitoring 27

### T

TCR 3, 18  
 Temperature coefficient 3, 18  
 Temperature control 4  
 Temperature meter 6, 25, 26, 31  
 Temperature monitoring 22  
 Temperature range 8, 23  
 Transformer 3, 7, 11, 31  
 Type of construction 8

### W

Wiring 10, 11