

Heating elements for sealing plastic films

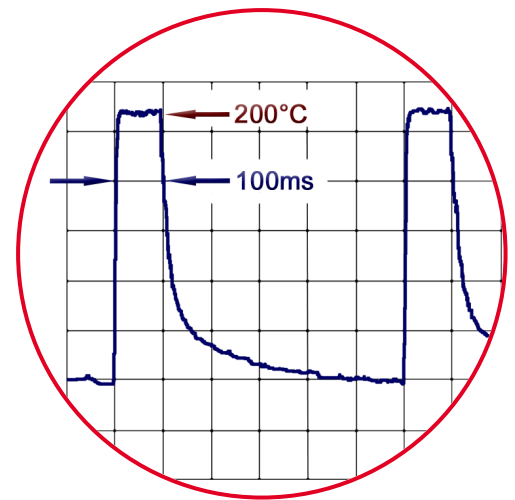

ULTRA-PULSE sealing bars

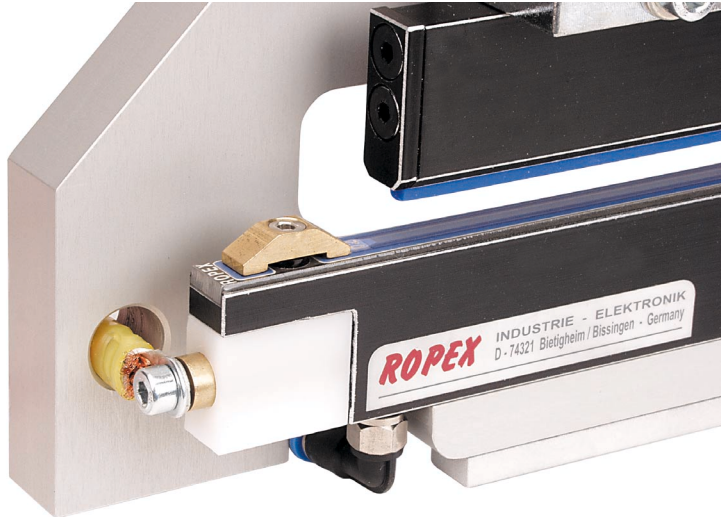
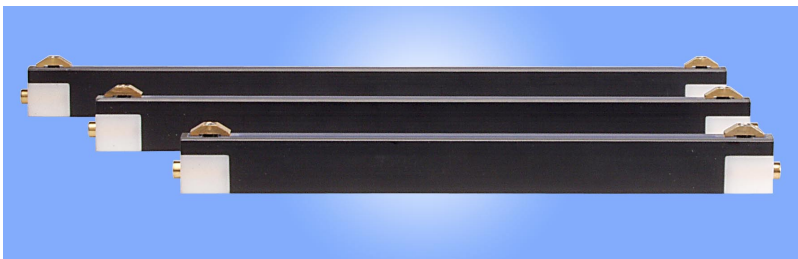

Temperature controllers for UPT and LPT heatsealing tools

LONG-PULSE heatsealing tools

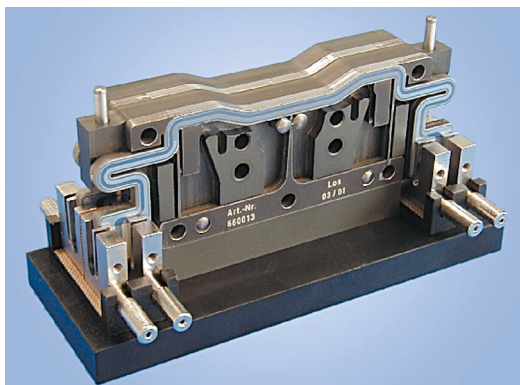

Contents

1. General	3
2. Structure of CIRUS heating elements	4
3. Ultra-pulse and long-pulse technology	5
3.1 Ultra-pulse technology (UPT)	5
3.2 Long-pulse technology (LPT)	6
4. System configuration	7
5. System characteristics	8
6. Design variants of ultra-pulse heatsealing tools	11
6.1 Design variants of opposing silicone bars	12
7. Film release after the heatsealing process	13
8. Standard components	14
8.1 Linear UPT heatsealing tools in standard lengths	14
8.2 Silicone retainers in standard lengths (opposing bar)	15
8.3 Silicone profiles	16
8.4 Impulse-transformers	16
9. Other system components	17
9.1 Temperature controllers	18
9.2 Line filters, current transformer, booster, cooler	18

1. General

CIRUS (Cermet Integrated Resistive Ultrafast Sensorless heaters) heatsealing tools are the outcome of an ongoing development process at ROPEX GmbH lasting many years. Extensive experience embracing more than 25 years as a leading supplier of systems to control the temperature of heatsealing bands laid the foundation for this new technology. (Patent Nos. 197 37 471 and 198 15 763)

CIRUS heatsealing tools have succeeded in overcoming the familiar drawbacks of conventional film sealing tools, namely in particular:

- The long temperature rise and cooling times
- The complex mechanical designs that are necessary:
 - a) To compensate thermal expansion
 - b) To ensure reliable current transfers
 - c) To avoid local overheating (coppering)
- The need to use anti-stick coverings (teflon)
- The restriction to specific formats
- The short service life
- The high costs of maintenance
- etc.

CIRUS heating elements

- Are extremely dynamic
- Have no moving parts
- Dispense with anti-stick coverings
- Are format-neutral
- Require no maintenance
- Are durable

In combination with specially tailored control loop components, such as a temperature controller (UPT/LPT-640), impulse-transformers (ITR-x), silicone profiles, a cooler etc., they provide ROPEX GmbH customers with an optimized overall system that guarantees reliable operation, thus saving both time and money.

**Benefit from integrated,
ready-to-operate solutions!**

2. Benefit from integrated, ready-to-operate solutions!

Several layers of glass-ceramic materials are applied to a plane, stainless steel substrate as insulation. Various layers of glass-metal materials are then applied in a defined geometry to act as a heating layer and for measuring the temperature. The final coating is a protective cover. Each time a new layer is applied, all the layers are sintered at +850 °C.

This results in a material-formed multilayer bond with properties previously unheard of in film sealing technology:

- The heating layer, which is only a few μm thick, has a very low thermal mass and capacity.
- The steel holder and the glass insulation have a very low lateral thermal conductivity.
- The gap between the hot heating layer and the film is only a few μm .
- Heating in impulse mode causes no change in the length of the heating layer.
- The almost unlimited choice of two-dimensional geometries for the heatsealing tools make them exceptionally versatile (e.g. shaped tools).

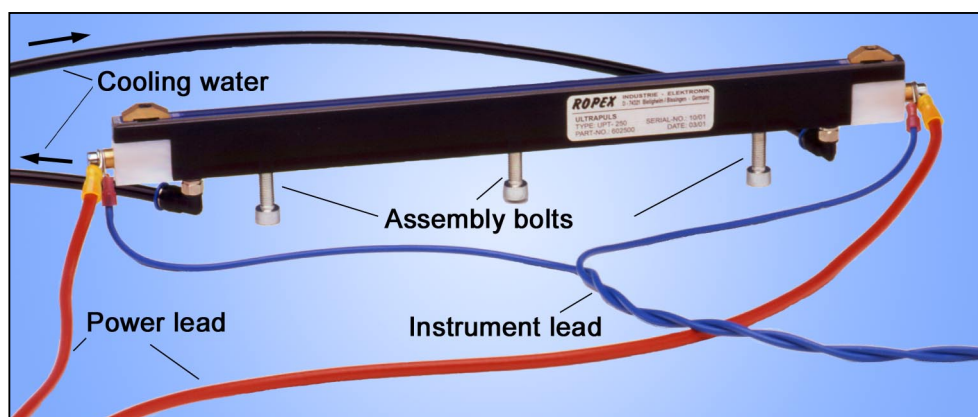
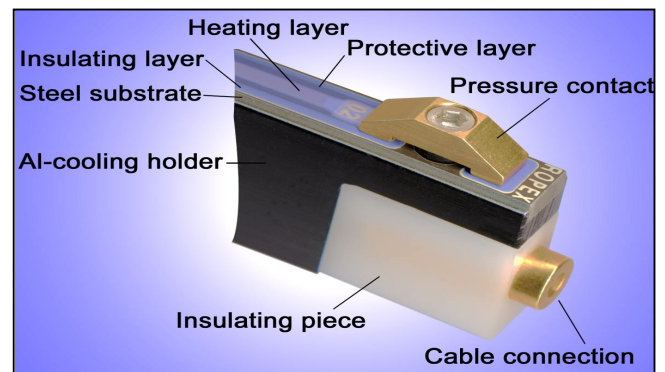
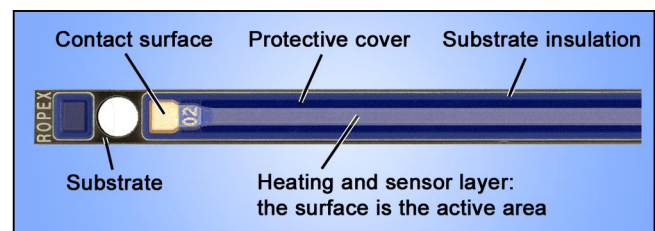
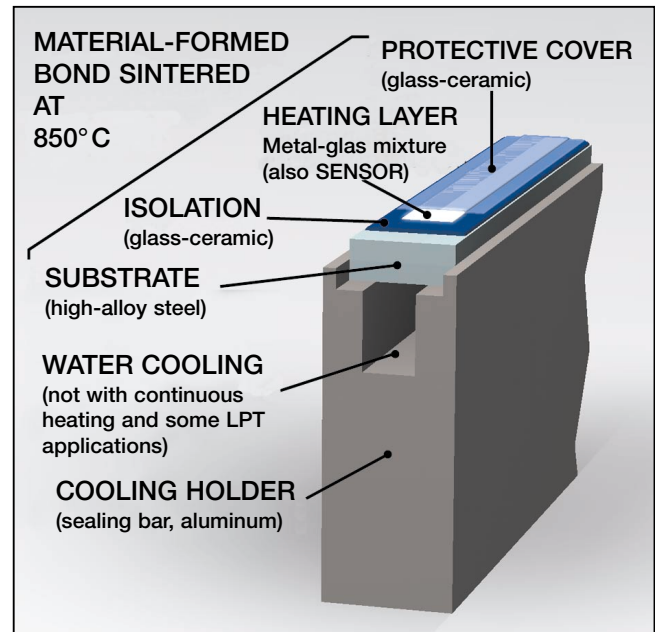

3. Ultra-pulse and long-pulse technology

Two different technologies are used for CIRUS heatsealing tools, depending on the tool design and mode of operation:

Ultra-Pulse-Technology (UPT) or Long-Pulse-Technology (LPT)

3.1 Ultra-pulse technology (UPT)

This technology generates heat impulses in the region of a few hundred milliseconds.

In addition to the UPT heatsealing tool, the system essentially consists of a UPT controller and a water cooler for the tool. The tool always operates in impulse mode. It is characterized by extremely short slope times for heating and cooling - typically around $6000^{\circ}\text{K/sec.}$ for heating and $3000^{\circ}\text{K/sec.}$ at the start of the cooling phase (e-function).

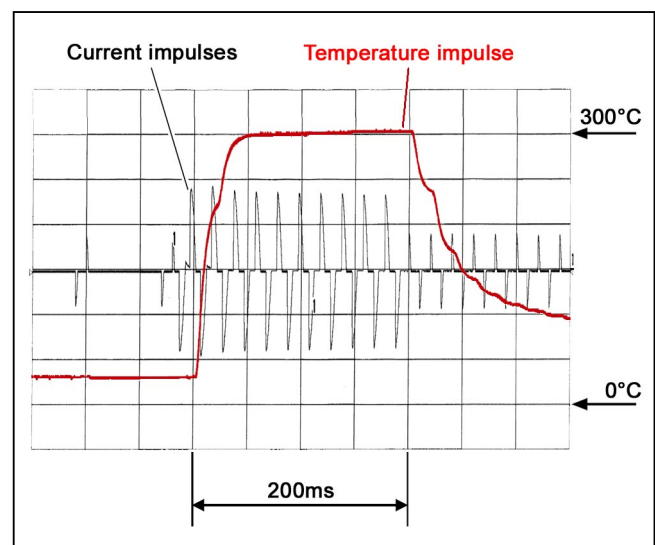

A special UPT controller ensures precise and highly dynamic temperature control. It is supported by the low mass of the heating layer (only a few μm thick), which simultaneously acts as the sensor layer for measuring the temperature.

The working surface for the sealing process is restricted to the area above the heating layer (-> "Structure").

ROPEX GmbH offers a range of linear UPT sealing bars for use in standard applications (-> section 8).

3.2 Long-pulse technology (LPT)

Long-pulse technology generates heat impulses from a few seconds right up to continuous heating.

The tool has to be cooled in heat impulse mode (e.g. with air or water), in contrast - by definition - with continuous heating.

The heating element consists of a heating layer and a separate sensor layer for measuring the temperature.

The two layers are formed in a common manufacturing process. The freely designable heating layer geometry enables temperature profiles to be defined and created. Furthermore, it is possible to compensate edge losses and heat sinks. The same applies to the sensor layer, which can be partially deactivated to permit the temperature to be measured only at points relevant to the process (Fig. b.).

The sensor layer can be applied either on the same plane as the heating layer or on the reverse of the substrate. The active working surface (heatsealing surface) can be optionally on the same plane as the heating layer or perpendicular to it.

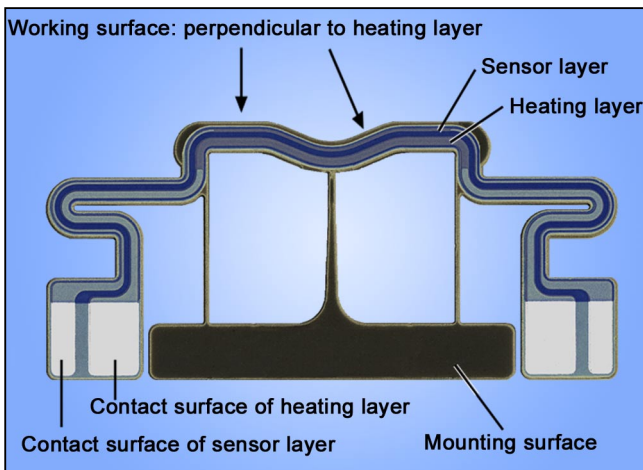

a.) Example of an LPT heatsealing tool with heating and sensor layers on one plane



An LPT controller specially tailored to the system takes care of temperature control.

In addition to sealing film, the unit also efficiently accomplishes other joining tasks, such as soldering or bonding.

LPT tools are customized solutions.

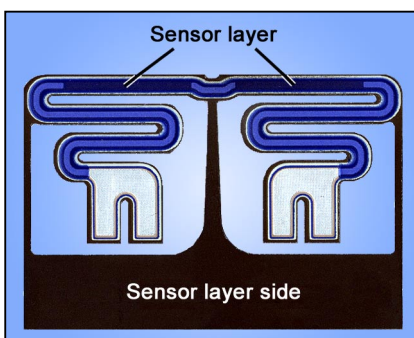

Front

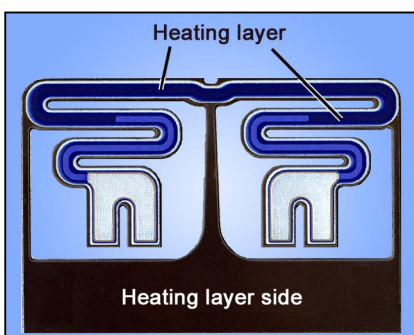

b.) Example of an LPT heatsealing tool with a partial sensor layer on the reverse

Reverse

4. System configuration

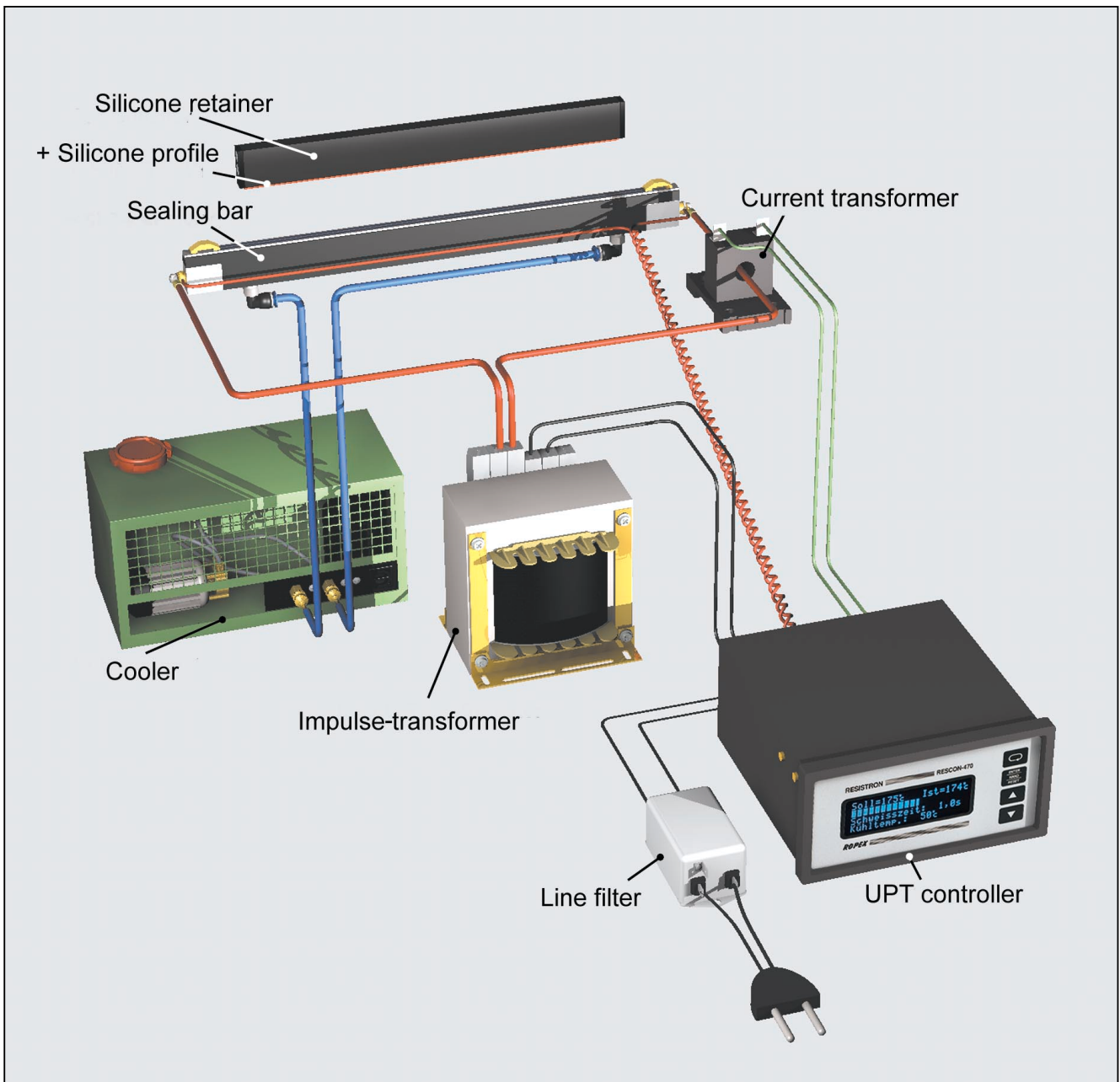

CIRUS heating elements, and in particular UPT heating elements, are high-performance systems which operate efficiently and reliably providing all the components in the control loop are optimally tuned to one another - and to the task at hand. Exact compliance with the installation and wiring instructions is essential. The system has been evolved and optimized by ROPEX GmbH in an intensive development process.

Users who follow with our technical recommendations will profit from the unique functionality of this technology, which reduces the customer's effort for installation, commissioning and maintenance to a minimum.

5. System characteristics

● Optimized thermal dynamics

The extremely fast temperature rise with typical slope steepnesses of 6000 °K/second, followed by rapid cooling after the heating phase, is the outstanding feature of CIRUS ULTRA-PULSE heatsealing tools.

The optimized thermal dynamics are the result of the physical properties and the structure of the layers, combined with the fact that the heating layers are only a few μm away from the sealing surface. Moreover, the heat for the sealing process no longer has to penetrate any insulating, anti-stick layers.

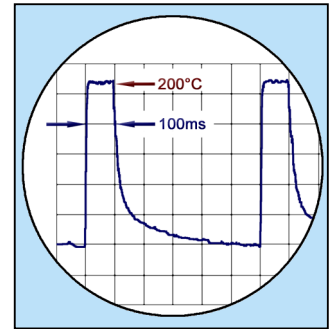

ULTRA-PULSE combines very short cycle times with previously unattainable seal strength after the tool is opened plus a heatseal that creates an excellent visual impression.

● Cold tools

The geometrically exact delimitation of the heated surface - in conjunction with the cooled holder - results in "cold tools" in impulse mode, in other words the sealing surface is only hot for a few hundred milliseconds during the heatsealing process. A few tenths of a second later, it has already cooled down.

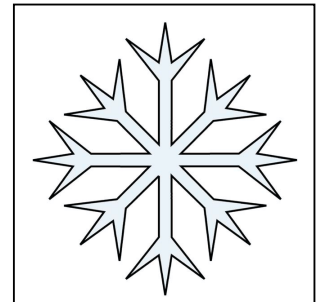

ULTRA-PULSE heatsealing tools radiate zero heat into the atmosphere!

● Simple, reliable design requiring practically no maintenance

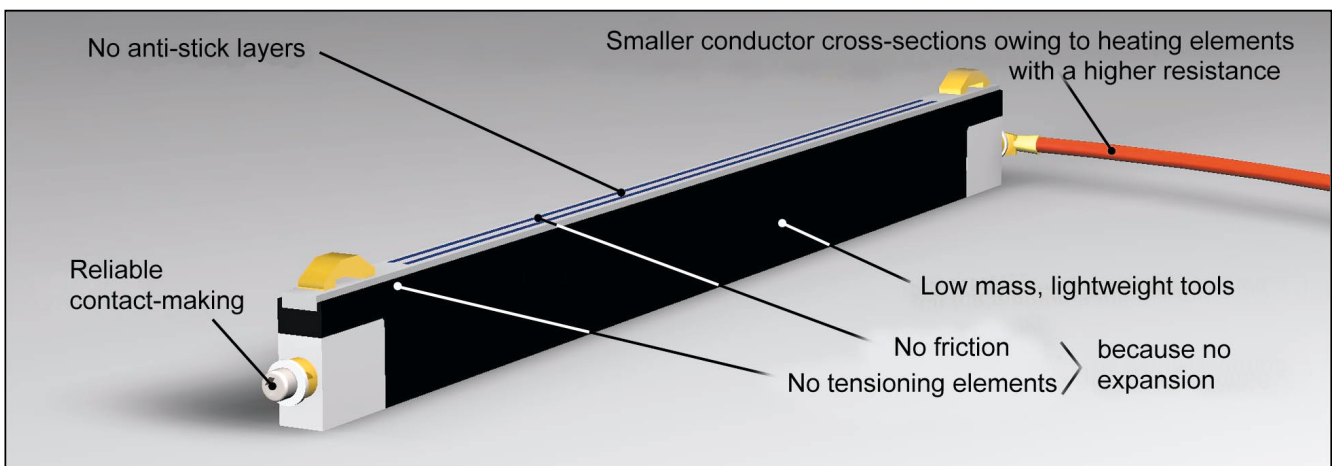

- **Long service life**

ULTRA-PULSE heating elements also endure a very large number of cycles under extreme, alternating thermal loads (impulse mode).

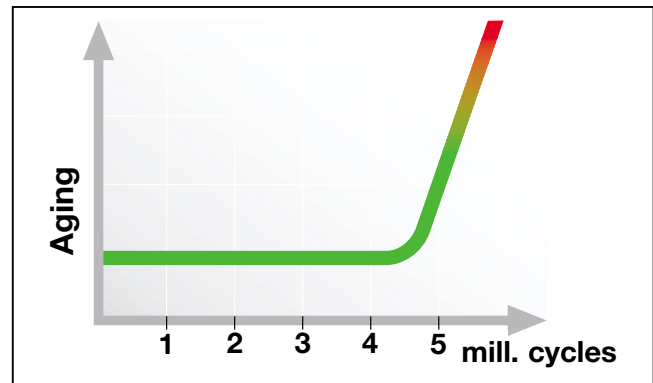

- **Format-neutral**

ULTRA-PULSE heating elements allow narrow webs of film to be processed with long sealing bars without any problems, because there is no temperature rise in the unloaded zones.

Partial thermal loading of the UPT heatsealing tool does not impair the heatseal quality in any way.

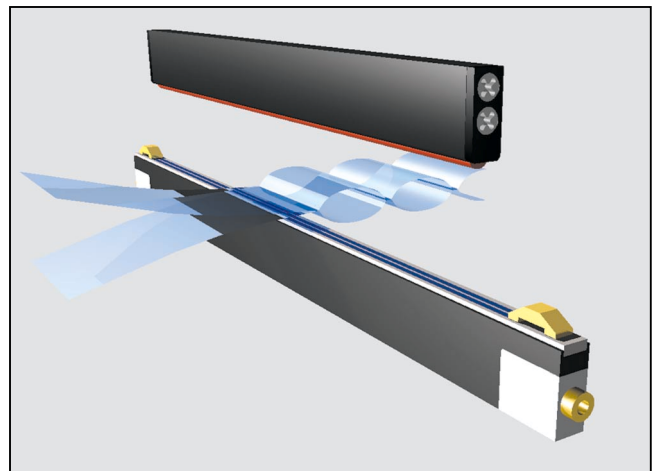

- **No anti-stick layers**

The fact that anti-stick layers can be dispensed with makes ULTRA-PULSE heatsealing tools extremely durable and practically maintenance-free.

Since the strength of the seal is restored almost instantly following the sealing pro-

cess, the film can either be simply pulled away from the heatsealing tool or released from it with the help of a short impulse (-> "Release impulse").

ULTRA-PULSE heating elements dispense with wearing anti-stick layers and are therefore guaranteed a long service life.

- **Minimal manufacturing tolerances**

The manufacturing process has matured over many years, leading to excellent reproducibility of the electrical and geometry data.

● **Temperature distribution on CIRUS heating elements**

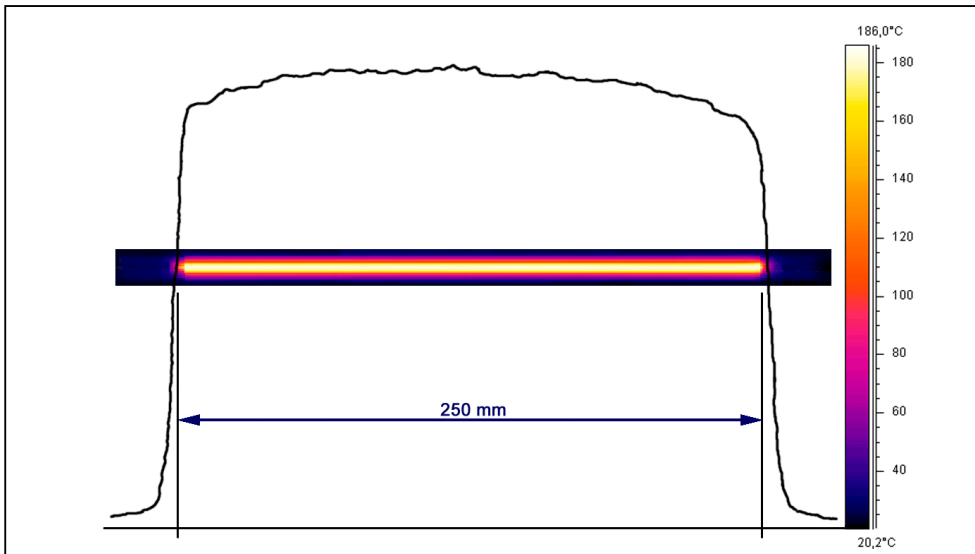

IR thermal images clearly reveal the extremely stable temperature in the longitudinal direction of a standard UPT sealing bar. The "sharpness" of the thermal image towards the cold outer zones is also easily recognizable.

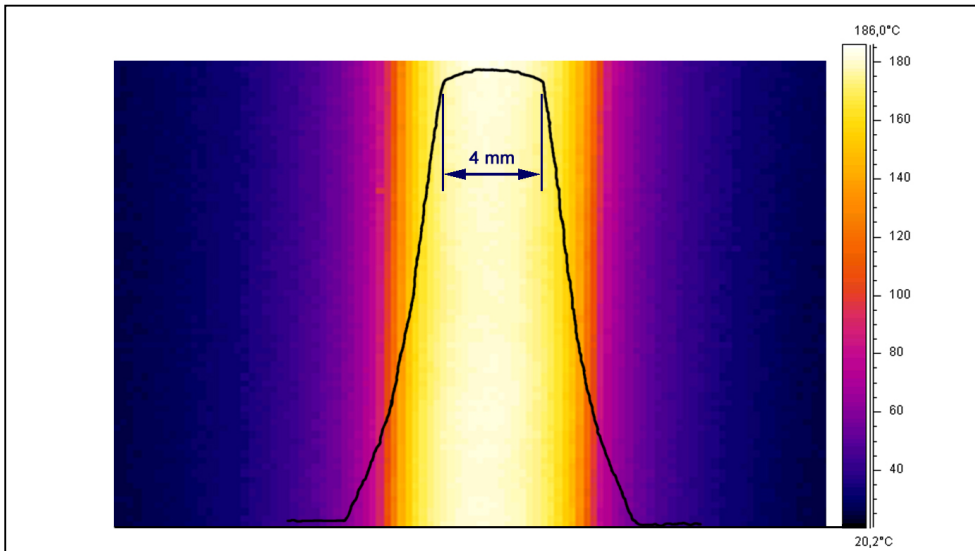

This thermogram shows the temperature profile perpendicular to the heating layer. The symmetry about the central axis is plainly visible.

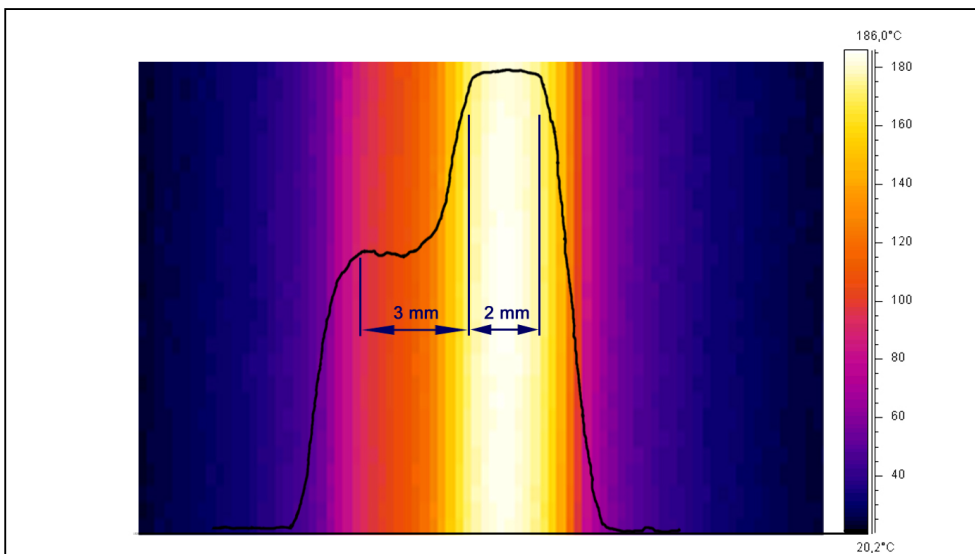

An asymmetrical layer structure allows other thermal cross-profiles to form in order, for instance, to achieve a heatseal with a larger "tail zone" - a distinct advantage with thick film.

6. Design variants of ULTRA-PULSE heatsealing tools

ROPEX offers a standard range of linear ULTRA-PULSE heatsealing tools in various lengths from 200 mm to 450 mm from stock.

The components are ready to install and connect (-> section 8), and are supplied with electrical and cooling water connections as well as tapped holes for mechanical assembly.

Customized solutions can be developed and manufactured alongside the standard tools. The maximum tool size is currently 140 mm x 500 mm. Two-dimensional heatsealing band geometries are possible on this surface with extensive design freedom. Low-cost multiple production is recommended for small heating elements.

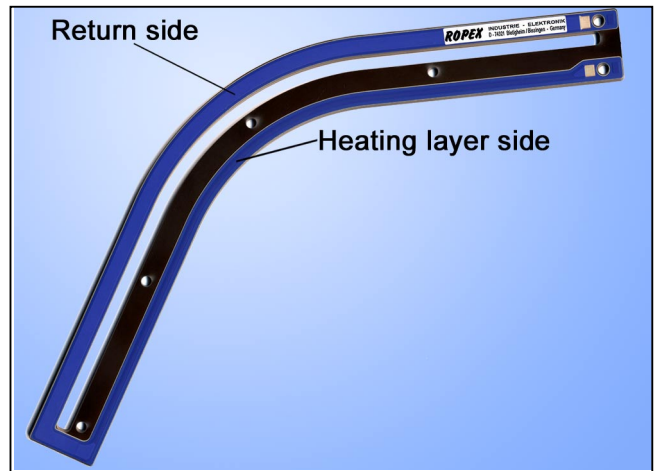
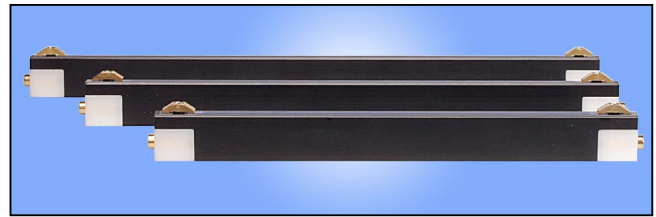

Combined tools with several heating layers in an integral or modular design represent another alternative.

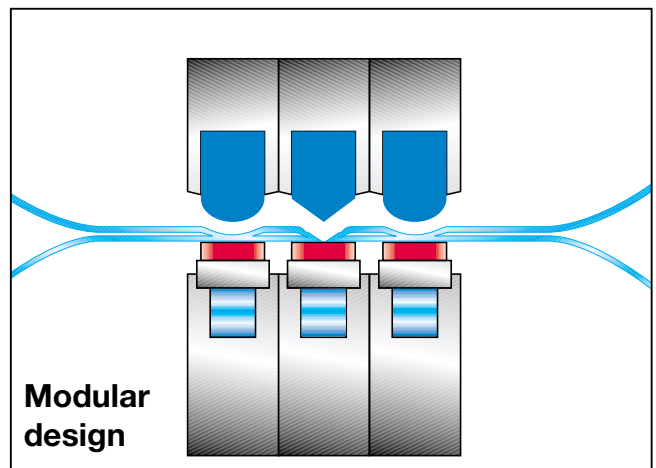
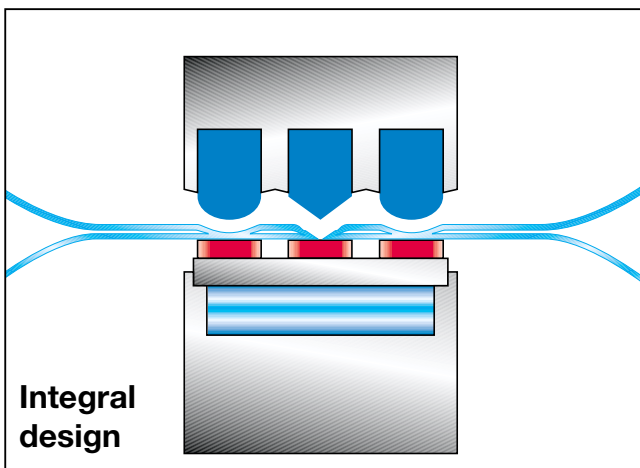
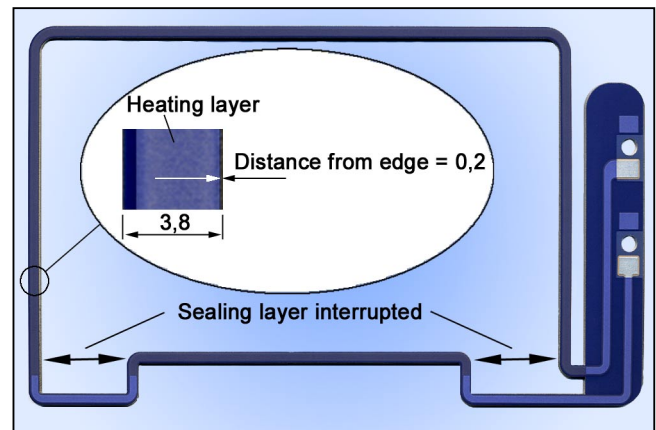

6.1 Design variants of opposing silicone bars

In contrast with conventional heatsealing band technology, where the sealing process is determined by the mechanical profile of the band (tapered band, beaded band, T-profile band, round wire), ULTRA-PULSE technology makes use of the cross-sectional geometry of the silicone profile on the opposite side.

Flat or trim seals with differently profiled tail zones can be created by combining different edge geometries of the silicone profile with different elastomer

hardnesses, facilitating optimum adaptation both to the task at hand and to the specific properties of the film.

In order to ensure that these processes are absolutely reliable, ROPEX offers precision silicone profiles in a variety of hardnesses with exact, constant cross-sectional geometries and the required high temperature resistance. Machined aluminum bars with tapered holes in the corresponding standard sealing lengths are available for mounting the silicone profiles (-> section 8).

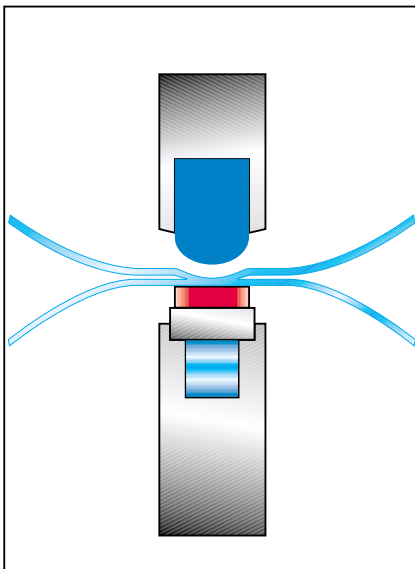

Flat seal

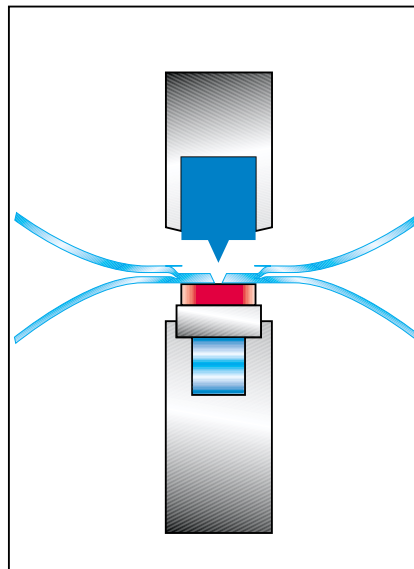

Trim seal with wide sealing zone

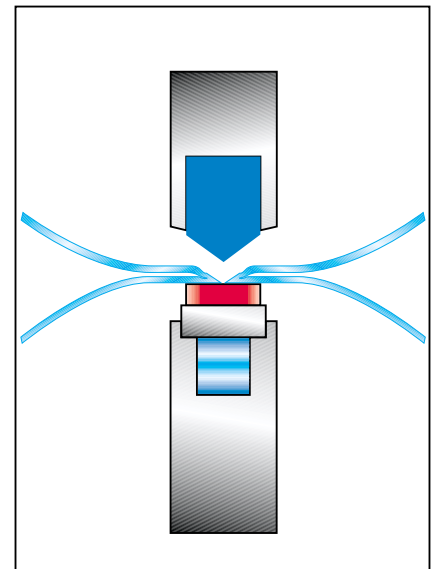

Trim seal with narrow sealing zone

7. Film release after the heatsealing process

The adhesion on an ULTRA-PULSE tool following the heatsealing process varies considerably from one film to another.

Some types of film hardly adhere at all to the tool surface and can therefore be released without any external assistance. Other films exhibit a slight-to-moderate tendency to stick. Since the strength of the heatseal is restored immediately after the sealing

process it is sufficient to apply a tensile force to these films in order to detach them from the tool surface. For example by opening the tool with the film still clamped inside it or simply through the weight of the packaged product.

If the film adheres strongly, it can be released from the tool subsequently by applying a short heat impulse.

Film release with a heat impulse (release impulse)

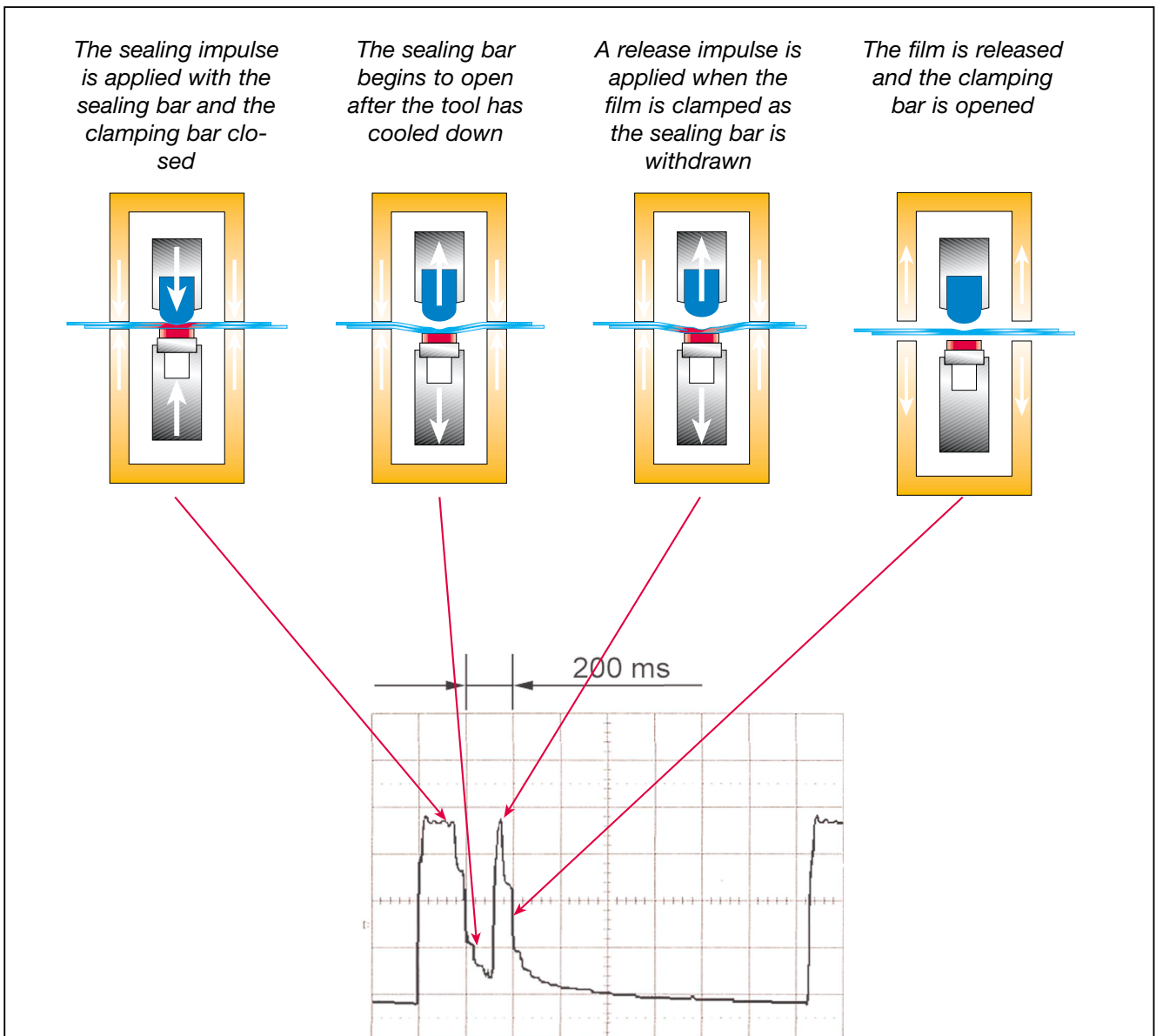

8. Standard components

The list below is only an excerpt from ROPEX GmbH's complete product range. ROPEX GmbH reserves the right to make technical alterations and/or improvements to all products.

8.1 Linear UPT heatsealing tools in standard lengths

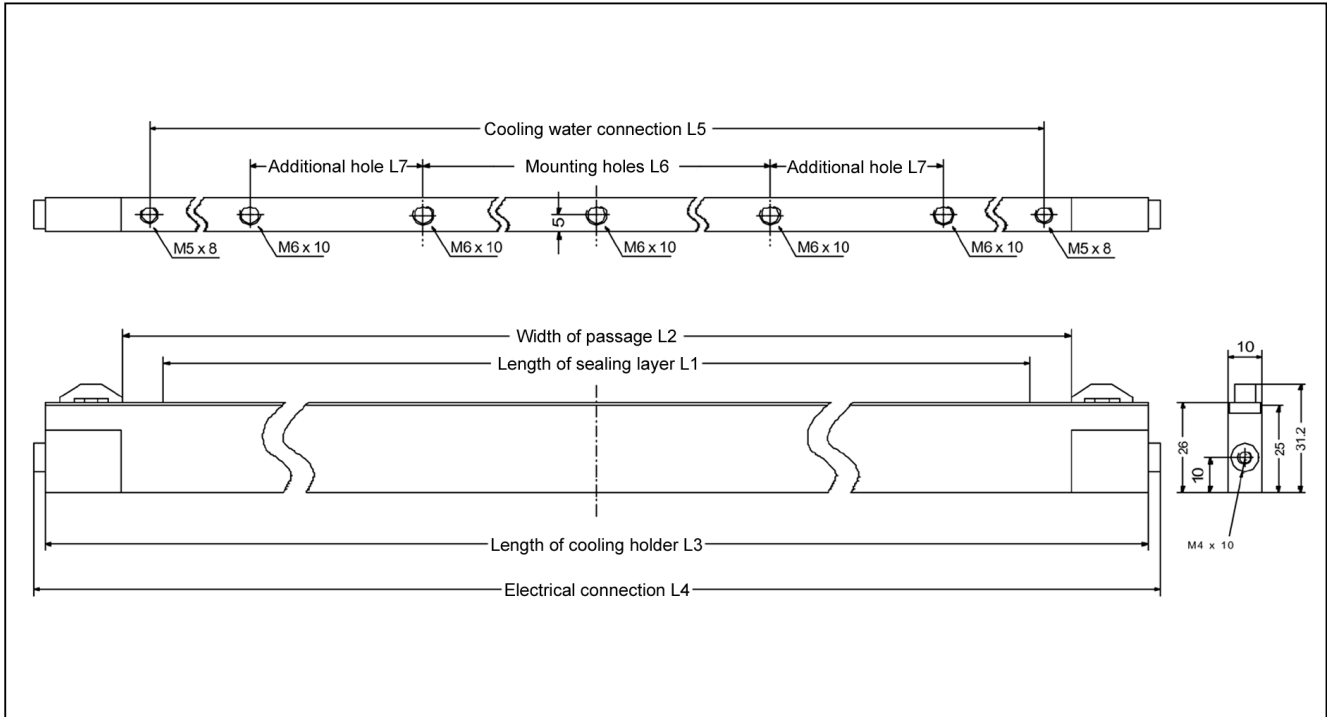

Article	Article no.	Sealing Layer width [mm]	L1 [mm]	L2 [mm]	L3 [mm]	L4 [mm]	L5 [mm]	L6 [mm]	L7 [mm]
UPT-200/2,8	60 20 00	2,8	200	223	268	275	208	150	n.v.
UPT-250/2,8	60 25 00	2,8	250	273	318	325	258	200	n.v.
UPT-300/2,8	60 30 00	2,8	300	323	368	375	308	200	n.v.
UPT-350/2,8	60 35 00	2,8	350	373	418	425	358	200	n.v.
UPT-400/2,8	60 40 00	2,8	400	423	468	475	408	200	n.v.
UPT-450/2,8	60 45 00	2,8	450	473	518	525	458	200	100

8.2 Silicone retainers in standard lengths (opposing bar)

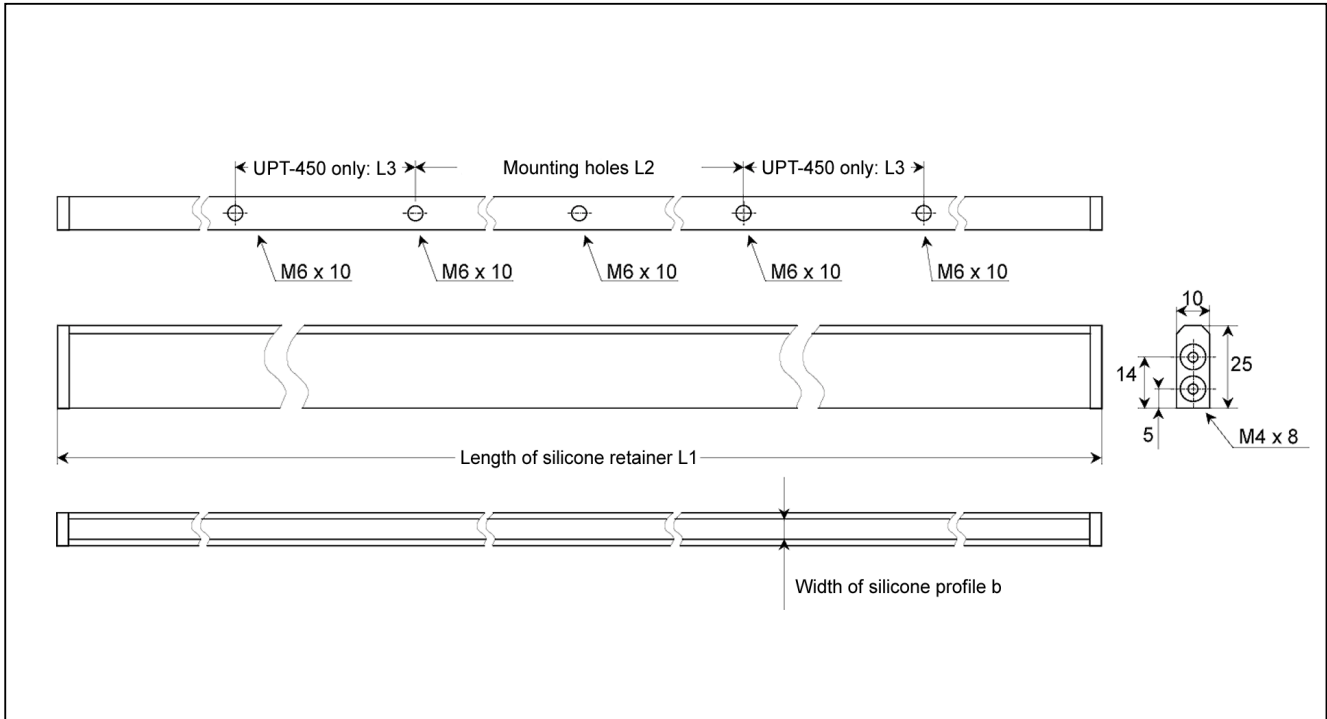

For silicone profile width $b = 4\text{mm}$

Article	Article no.	L1 [mm]	L2 [mm]	L3 [mm]
SH-200/4	64 20 04	211	150	n.v.
SH-250/4	64 25 04	261	200	n.v.
SH-300/4	64 30 04	311	200	n.v.
SH-350/4	64 35 04	361	200	n.v.
SH-400/4	64 40 04	411	200	n.v.
SH-450/4	64 45 04	461	200	100

For silicone profile width $b = 6\text{mm}$

Article	Article no.	L1 [mm]	L2 [mm]	L3 [mm]
SH-200/6	64 20 06	211	150	n.v.
SH-250/6	64 25 06	261	200	n.v.
SH-300/6	64 30 06	311	200	n.v.
SH-350/6	64 35 06	361	200	n.v.
SH-400/6	64 40 06	411	200	n.v.
SH-450/6	64 45 06	461	200	100

8.3 Silicone profiles

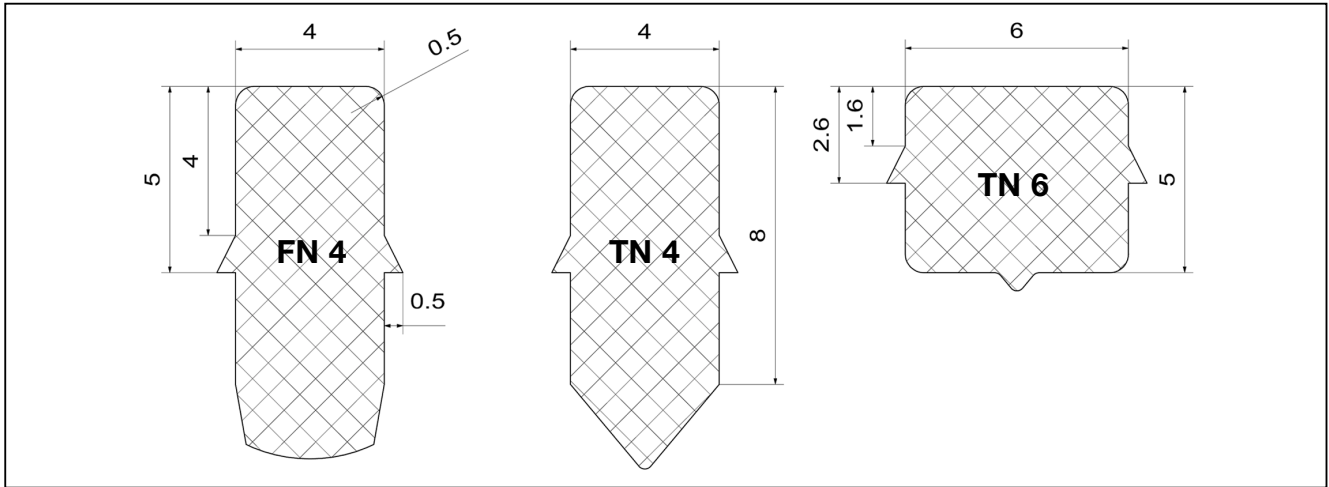

Flat seal profile FN 4

Article	Article-no.	Hardness [Shore]
SF40S/FN/4	65 40 40	40
SF60S/FN/4	65 60 40	60
SF80S/FN/4	65 80 40	80

Trim seal profile TN 4

Article	Article-no.	Hardness [Shore]
SF80S/TN/4	65 80 41	80

Trim seal profile TN 6

Article	Article no.	Hardness [Shore]
SF80S/TN/6	65 80 61	80

Remark:

All silicone profiles will be delivered in the length of 450 mm.

8.4 Impulse-transformers

ROPEX impulse-transformers are specially optimized for supplying UPT sealing bars used in combination with UPT controllers.

Transformer	Output KVA	Duty cycle %	Primary voltage V	Secondary voltages V	Suitable for UPT sealing bars
ITR-3/2	3	20	400v ± 10%	40- 50 - 60	UPT
ITR-3/5		50			200 / 250 / 300
ITR-4.5/2	4,5	20		70- 80 - 90	UPT
ITR-4.5/5		50			350 / 400 / 450



Practical examples

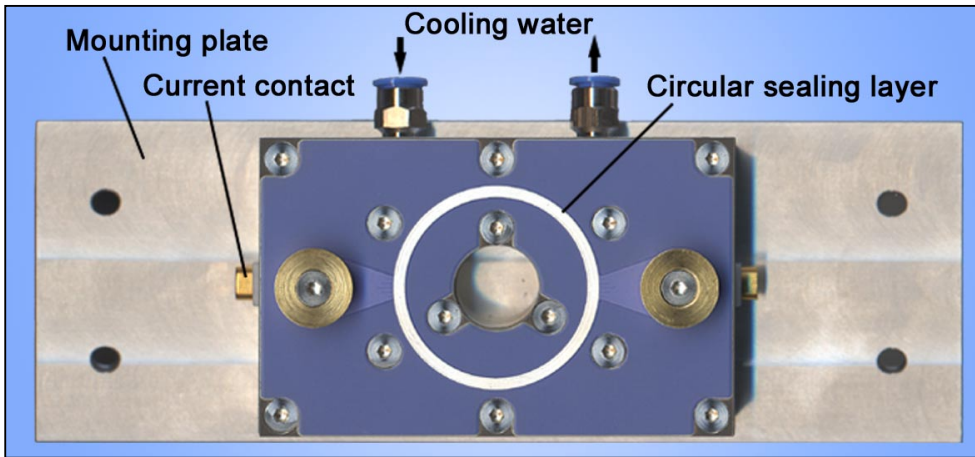

ULTRA-PULSE ring heater

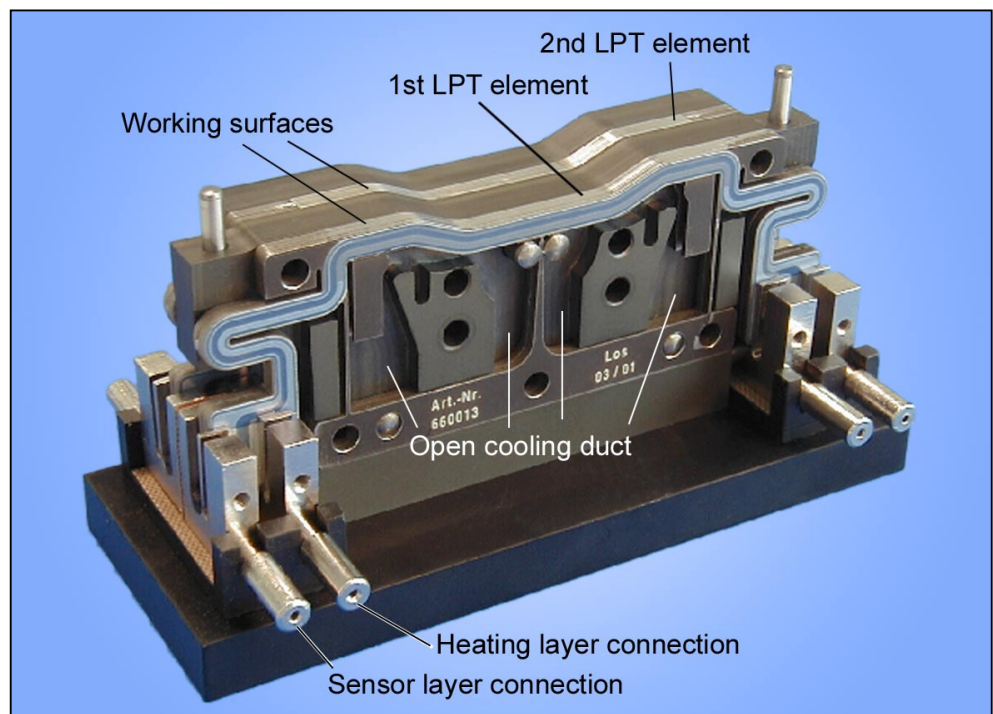

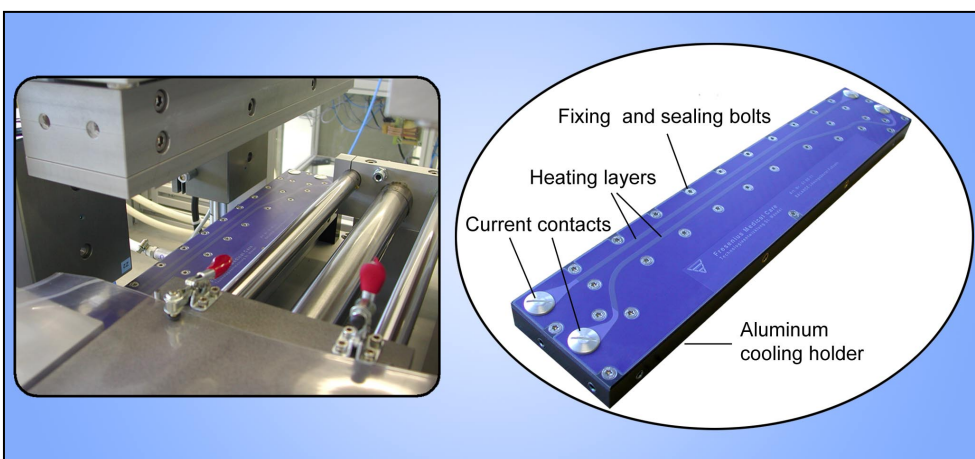

LONG-PULSE tool for double contour heatseal



ULTRA-PLUSE double heatsealing tool

Temperature controllers for CIRUS heating elements

SERIES „600“	TYPE OF CONTROLLER	TYPE OF CONSTRUCTION	DISPLAY	AUTOCAL	TEMPERATURE SETTING AND INDICATION	DIAGNOSIS	BOOSTER OUTPUT	RELEASE IMPULSE	PREHEATING	MEAS. INPUT FOR TEMP-SENSOR
UPT-640-L		LCD	Via menu or external control signal (24V)	Via menu or external analog signal (0-10V)	●	●	●	—	—	
UPT-640-V		VFD								
LPT-640-L		LCD	Via menu or external control signal (24V)	Via menu or external analog signal (0-10V)	●	●	—	●	●	
LPT-640-V		VFD								

LCD: Liquid crystal display (green) VFD: Vacuum fluorescent display (blue)

Other system components (see also “Accessories“ leaflet)

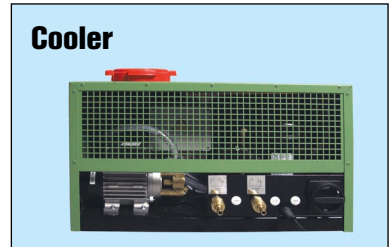
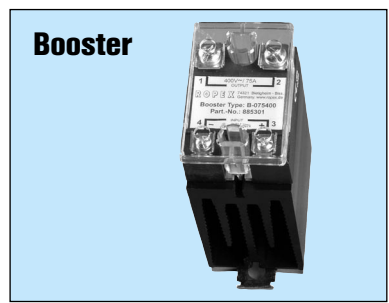
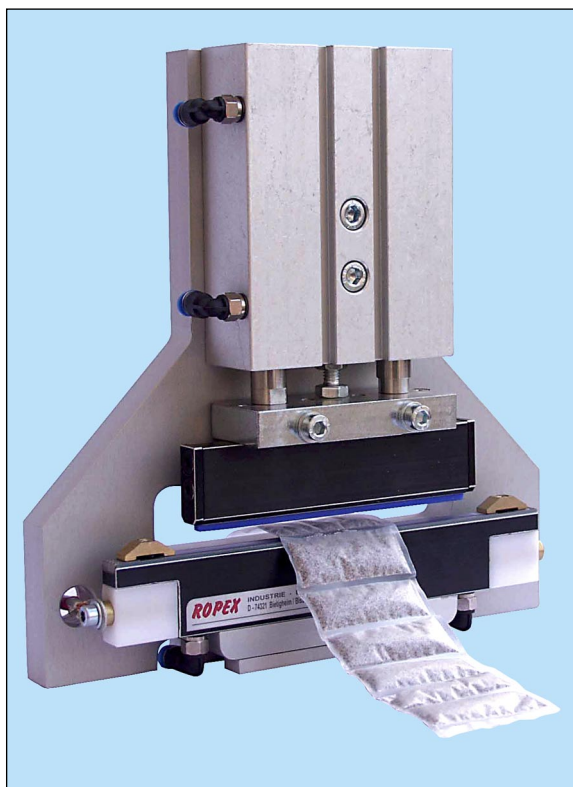

Data subject to change · 06/02

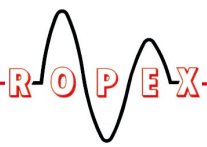

INDUSTRIE-ELEKTRONIK

Agents in:

- Denmark / Scandinavia
- Italy / Switzerland
- U.S.A. / Canada
- Mexiko / South America
- South Africa
- New Zealand / Australia